

# OPERATION MANUAL

## Torque sensor Model 8661

© 2018 burster  
praezisionsmesstechnik gmbh & co kg  
All rights reserved

Manufacturer:

burster  
praezisionsmesstechnik gmbh & co kg  
Talstr. 1 - 5 P.O. 1432  
76593 Gernsbach 76593 Gernsbach  
Germany Germany

Valid from: 22.05.2018

Tel.: +49-7224-645-0  
Fax.: +49-7224-645-88  
Email: [info@burster.com](mailto:info@burster.com)  
[www.burster.com](http://www.burster.com)

2742-BA8661EN-5170-051523

## Exclusion of warranty liability for operating manuals

All information in the present documentation was prepared and compiled with great care and reproduced subject to effective control measures. No warranty is provided for freedom from errors. We reserve the right to make technical changes. The present information as well as the corresponding technical data can change without notice. Reproduction of any part of this documentation or its processing or revision using electronic systems is prohibited without the manufacturer's prior written approval.

Components, devices and measured value sensors made by burster praezisionsmesstechnik (hereinafter referred to as "product") are the results of targeted development and meticulous research. As of the date of delivery, burster provides a warranty for the proper condition and functioning of these products covering material and production defects for the period specified in the warranty document accompanying the product. However, burster excludes guarantee or warranty obligations as well as any liability beyond that for consequential damage caused by improper use of the product, in particular the implied warranty of success in the market as well as the suitability of the product for a particular purpose. Furthermore, burster assumes no liability for direct, indirect or incidental damages as well as consequential or other damages arising from the provision and use of the present documentation.

### Trademark information

Intel Pentium® is a registered trademark of Intel Corporation. Windows®, Excel® are registered trademarks or trademarks of Microsoft Corporation in the United States and/or other countries.

All brand or product names mentioned in this document are trademarks or registered trade-marks of their respective trademark owners. By mentioning these trademarks burster praezisionsmesstechnik gmbh & co kg is not laying claim to trademarks other than its own.

The measurement solution.



## EU-Konformitätserklärung (nach EN ISO/IEC 17050-1:2010) EU-Declaration of conformity (in accordance with EN ISO/IEC 17050-1:2010)

**Name des Ausstellers:** burster präzisionsmesstechnik gmbh & co kg  
*Issuer's name:*

**Anschrift des Ausstellers:** Talstr. 1-5  
*Issuer's address:* 76593 Gernsbach, Germany

**Gegenstand der Erklärung:** Präzisions-Drehmomentsensor + Steckernetzteil  
*Object of the declaration:* Precision Torque Sensor + power pack

Modellnummer(n) (Typ): 8661 + 8600-Z010  
*Model number / type:*

Diese Erklärung beinhaltet obengenannte Produkte mit allen Optionen  
*This declaration covers all options of the above product(s)*

**Das oben beschriebene Produkt ist konform mit den Anforderungen der folgenden Dokumente:**  
*The object of the declaration described above is in conformity with the requirements of the following documents:*

<b>Dokument-Nr.</b> <i>Documents No.</i>	<b>Titel</b> <i>Title</i>	<b>Ausgabe</b> <i>Edition</i>
2011/65/EU	Richtlinie zur Beschränkung der Verwendung bestimmter gefährlicher Stoffe in Elektro- und Elektronikgeräten <i>Directive on the restriction of the use of certain hazardous substances in electrical and electronic equipment</i>	2011
2014/35/EU	Richtlinie zur Harmonisierung der Rechtsvorschriften der Mitgliedsstaaten über die Bereitstellung elektrischer Betriebsmittel zur Verwendung innerhalb bestimmter Spannungsgrenzen auf dem Markt <i>Directive on the harmonization of the laws of the Member States relating to the making available on the market of electrical equipment designed for use within certain voltage limits</i>	2014
2014/30/EU	Richtlinie zur Harmonisierung der Rechtsvorschriften der Mitgliedsstaaten über die Elektromagnetische Verträglichkeit <i>Directive on the harmonization of the laws of the Member States relating to electromagnetic compatibility</i>	2014
EN 61010-1	Sicherheitsbestimmungen für elektrische Mess-, Steuer-, Regel- und Laborgeräte – Teil 1: Allgemeine Anforderungen <i>Safety requirements for electrical equipment for measurement, control and laboratory use – Part 1: General requirements</i>	2010 + Cor.:2011
EN 61326-2-3	Elektrische Mess-, Steuer-, Regel- und Laborgeräte – EMV-Anforderungen – Teil 2-3: Besondere Anforderungen <i>Electrical equipment for measurement, control and laboratory use – EMC requirements – Part 2-3: Particular requirements</i>	2006
EN 55011	Industrielle, wissenschaftliche und medizinische Geräte – Funkstörungen – Grenzwerte und Messverfahren <i>Industrial, scientific and medical equipment – Radio-frequency disturbance characteristics – Limits and methods of measurement</i>	2009

Gernsbach  
*Ort / place*

20.04.2016  
*Datum / date*

i.V. Christian Karius  
*Quality Manager*

Dieses Dokument ist entsprechend EN ISO/IEC 17050-1:2010 Abs. 6.1g ohne Unterschrift gültig  
*According to EN ISO/IEC 17050 this document is valid without a signature.*

burster präzisionsmesstechnik gmbh & co kg · Talstr. 1-5 DE-76593 Gernsbach (P.O.Box 1432 DE-76587 Gernsbach) · Tel. +49-7224-6450 · Fax 645-88  
[www.burster.com](http://www.burster.com) · [info@burster.com](mailto:info@burster.com) · burster is ISO 9001:2008 certified

Geschäftsführer/Managing Director: Matthias Burster · Handelsregister/Trade Register: Gernsbach · Registergericht/Register Court: Mannheim HRA 530170  
Kompl./Gen. Partn.: burster präzisionsmesstechnik Verwaltungs-GmbH · Handelsregister/Trade Register: Gernsbach · Registergericht/Register Court: Mannheim HRB 530130  
UST-Identnr./VAT No. DE 144 005 098 · Steuernr./Tax Ident No. 39454/10503  
Commerzbank AG Rastatt Kto./Acc. 06 307 073 00 BLZ/Bank code 662 800 53 · Volksbank Baden-Baden\* Rastatt eG Kto./Acc. 302 082 00 BLZ/Bank code 662 900 00

## Table of contents

<b>1</b>	<b>Safety instructions</b> .....	<b>7</b>
1.1	Symbols in this manual .....	7
1.1.1	Signal words .....	7
1.1.2	Pictograms .....	7
1.2	General safety instructions .....	8
<b>2</b>	<b>Introduction</b> .....	<b>9</b>
2.1	Intended use .....	9
2.2	Customer service .....	9
2.2.1	Customer service department .....	9
2.2.2	Contact person .....	9
2.3	Environmental conditions .....	10
2.3.1	Storage conditions .....	10
2.3.2	Cleaning .....	10
2.4	Personnel .....	10
2.5	Scope of delivery .....	11
2.6	Unpacking .....	11
2.7	Warranty .....	11
2.8	Conversions and modifications .....	12
2.9	Definitions .....	13
<b>3</b>	<b>Device design and general information</b> .....	<b>15</b>
3.1	Mechanical design .....	15
3.2	Principle of operation .....	16
3.3	Static and quasi-static torques .....	16
3.4	Dynamic torques .....	16
3.5	Interference .....	17
<b>4</b>	<b>Installation</b> .....	<b>18</b>
4.1	Preparing for installation .....	18
4.2	Mechanical installation .....	19
4.2.1	Installation using mounting block .....	19
4.2.2	Free-floating installation .....	21
<b>5</b>	<b>Torque sensor model 8661 with analog connection</b> .....	<b>23</b>
5.1	Electrical connection .....	23
5.1.1	Power supply .....	23
5.1.2	Connector pin assignments (standard sensor, 1 range) .....	23
5.1.3	The connections in detail .....	24
5.1.4	Running cables .....	26
5.1.5	Extension cables .....	27
5.2	Measurement .....	28
5.2.1	Switching on .....	28
5.2.2	Status display (standard sensor, 1 range) .....	28

# Model 8661

5.2.3	Speed limits .....	28
5.2.4	Check function .....	28
<b>6</b>	<b>USB version of the torque sensor model 8661 .....</b>	<b>29</b>
6.1	Electrical connection.....	29
6.1.1	Power supply .....	30
6.1.2	USB 2.0 pin assignment .....	30
6.1.3	Ground connection.....	31
6.1.4	Wiring.....	31
<b>7</b>	<b>Software DigiVision.....</b>	<b>32</b>
7.1	Device list / device detection .....	32
7.2	Device settings .....	33
7.2.1	Settings .....	34
7.2.2	Limits.....	35
7.2.3	Properties.....	35
7.3	Properties, measurement rate etc. ....	36
7.3.1	General information .....	36
7.3.2	Selecting the measurement rate.....	37
7.4	Measurement-mode settings .....	38
7.4.1	Basic configuration.....	39
7.4.2	Channel settings .....	39
7.4.3	Trigger.....	40
7.4.4	Documentation.....	41
7.5	Display .....	41
7.6	Start / stop a measurement .....	43
7.7	Measurement reports .....	44
7.7.1	Measurement report finder .....	44
7.7.2	Archive viewer.....	45
7.7.3	Exporting reports to Excel.....	46
7.7.4	Print reports .....	47
<b>8</b>	<b>Software DigiVision.....</b>	<b>49</b>
8.1	System requirements.....	49
8.2	Software installation .....	49
8.2.1	Driver installation .....	53
8.2.2	Installation for the virtual COM port .....	57
8.2.3	Data storage .....	61
8.3	Software version & licensing .....	61
8.3.1	8661-P001 .....	61
8.3.2	8661-P100 .....	62
8.3.3	8661-P200 .....	63
8.3.4	Licensing.....	64
<b>9</b>	<b>Options .....</b>	<b>65</b>
9.1	Angle / speed measurement.....	65

9.1.1	General information .....	65
9.1.2	Details .....	65
9.2	Dual-range sensor .....	67
9.2.1	Switching between ranges (dual-range sensor) .....	67
9.2.2	Possible range extension of the nominal torque.....	67
9.2.3	Switching between measurement range.....	67
9.2.4	Connector pin assignments (dual-range sensor, not USB) .....	67
9.2.5	Connection diagram (dual-range sensor, not USB).....	68
9.2.6	Status display (dual-range sensor) .....	69
<b>10</b>	<b>Calibration and adjustment .....</b>	<b>70</b>
10.1	Factory calibration .....	70
10.2	DAkKS (DKD) calibration (DIN 51309).....	70
10.3	Recalibration .....	70
<b>11</b>	<b>Taking out of use .....</b>	<b>71</b>
<b>12</b>	<b>Technical data.....</b>	<b>72</b>
12.1	Electromagnetic compatibility .....	72
12.1.1	Interference immunity .....	72
12.1.2	Emitted interference .....	72
<b>13</b>	<b>Accessories .....</b>	<b>73</b>
13.1	Software.....	73
<b>14</b>	<b>Disposal.....</b>	<b>74</b>

# Model 8661



## 1 Safety instructions

On the torque sensor model 8661 and in this manual the following symbols warn about risks.

### 1.1 Symbols in this manual

#### 1.1.1 Signal words



The following signal words are used in the operation manual according to the specified hazard classification.

	<b>DANGER</b>
<b>DANGER</b> indicates a hazard with a high level of risk which, if not avoided, will result in death or serious injury.	
	<b>WARNING</b>
<b>WARNING</b> indicates a hazard with a medium level of risk which, if not avoided, could result in death or serious injury.	
	<b>CAUTION</b>
<b>CAUTION</b> indicates a hazard with a low level or risk which, if not avoided, could result in minor or moderate injury.	
<b>NOTICE</b>	
Property damage to the equipment or the surroundings will result if the hazard is not avoided.	

**Note:** It is important to heed these safety instructions in order to ensure correct handling of the torque sensor model 8661.



**IMPORTANT:** Follow the information given in the operation manual.

#### 1.1.2 Pictograms

	<b>Danger of electric shock!</b>
	Observe the safety notices for protecting the torque sensor model 8661.

## 1.2 General safety instructions

The torque sensor model 8661 uses state-of-the-art engineering and is safe to operate. However, if the torque sensor model 8661 is not used or operated as intended, it may present a hazard.

	 <h3 style="margin: 0;">DANGER</h3>
	<p><b>Danger of electric shock!</b>  <b>The following instructions must be followed to prevent electric shock and injuries:</b></p> <ul style="list-style-type: none"> <li>• In order to achieve high measuring characteristic value, the torque sensor model 8661 is <b>not</b> designed with the usual safety factors (2...20) for machine designs. For applicable overload factors, see the technical data (data sheet).</li> <li>• Observe accident prevention regulations, including for accessories used.</li> <li>• Use torque sensor model 8661 only in <b>non-safety-critical applications</b>.</li> <li>• Only use torque sensor model 8661 <b>outside of potentially explosive areas</b> (Ex protected areas).</li> </ul>

<h2 style="margin: 0;">NOTICE</h2>
<p><b>The following points must be observed to prevent injuries and damage to property:</b></p> <ul style="list-style-type: none"> <li>• The limits for permissible mechanical, thermal and electrical loads are shown in the data sheet. These limits must not be exceeded. Take these limits into account when planning the measuring arrangement, and during installation (preferably with the display for the torque connected) and operation.</li> <li>• Impacts and shocks may damage the torque sensor model 8661 (e.g. if it is dropped). Exercise the necessary care when transporting and fitting the sensor.</li> <li>• Torque peaks in excess of the permissible overload may destroy the torsion shaft. Make sure that such peaks do not occur, or ensure that they are absorbed.</li> </ul>



## 2 Introduction

**IMPORTANT:** Read the operation manual carefully before using the equipment, and keep for future reference.

### 2.1 Intended use

The torque sensor model 8661 measures static and dynamic torques on rotating or stationary machine parts in either direction of rotation. You have the option of measuring rotational speed or angular displacement. The respective upper range value is shown on the type plate. The USB version of the 8661 torque sensor model 8661 transmits all measurement signals via USB.

Both the low mass of the torque sensor model 8661 and its high torsional rigidity are an advantage when measuring dynamic torques. However, you need to pay attention to the torsion spring constant and the sensor's cut-off frequency with such measurements. You can find both of these in the data sheet. For more information on estimating the resonant frequency and measuring dynamic torques see chapter 3.4 "Dynamic torques" on page 16.

The torque sensor model 8661 is maintenance-free thanks to its contactless transmission of the measurement signal. The electrical measurement signals can be transmitted to remote measuring stations where they can be displayed, recorded, processed and used for control and regulation tasks.

Use the torque sensor model 8661 only for measuring torque and rotational speed or angular displacement.

Do **not** use the torque sensor model 8661 in safety-critical applications.

The torque sensor model 8661 is not intended for use as a safety device.

### 2.2 Customer service

#### 2.2.1 Customer service department

If you need to ask about repairs, please telephone our Service department on +49-7224-645-53.

Please have the serial number to hand. The serial number is essential to establishing the definite technical status of the torque sensor model 8661 and providing help quickly. You will find the serial number on the type plate of the torque sensor model 8661.

#### 2.2.2 Contact person

If you have any questions relating to the torque sensor model 8661, please contact your representative or go directly to burster präzisionsmesstechnik gmbh & co. kg.

##### Headquarters

burster praezisionsmesstechnik gmbh & co kg  
Talstr. 1 - 5  
76593 Gernsbach  
Germany

Tel: +49-7224-645-0  
Fax: +49-7224-645-88  
Email: [info@burster.com](mailto:info@burster.com)

## 2.3 Environmental conditions



- Avoid radiant heat or cooling from one side.
- Protect the torque sensor model 8661 from moisture.
- The torque sensor model 8661 is **not** resistant to the effects of chemicals. **Do not** use the torque sensor model 8661 in a corrosive environment.
- Keep the bearings and connectors free of dust, dirt and other foreign matter.

### 2.3.1 Storage conditions

Use clean packaging to package the torque sensor model 8661. The torque sensor model 8661 must be stored under the following conditions:

- Dry atmosphere
- No condensation
- Temperature between +0 °C and +60 °C

### 2.3.2 Cleaning

	 <b>DANGER</b>
	<p><b>Electric shock hazard!</b> Disconnect the torque sensor model 8661 from the electrical supply before cleaning.</p>

Disconnect the torque sensor model 8661 from the power supply and use a dry cloth to clean it.

	<b>CAUTION</b>
	<p><b>Do not</b> immerse the torque sensor model 8661 in water or hold it under running water. Do not use strong cleaning agents as these may damage the torque sensor model 8661. Use a dry cloth to clean the device. Ensure that the shaft and mating parts are completely clean and have no traces of lubricants at the time of fitting. Use a solvent such as acetone to clean the shafts before fitting. Make sure there is no foreign matter on the shafts at fitting.</p>

## 2.4 Personnel



Personnel must be familiar with the relevant regulations. They must follow these regulations. Only trained personnel who are familiar with the applicable safety regulations are permitted to operate the torque sensor model 8661.

# Model 8661

## 2.5 Scope of delivery

- Torque sensor model 8661
- Mating connector
- Operation manual
- Data sheet
- Optional: USB cable

## 2.6 Unpacking

	 <p><b>DANGER</b></p> <p><b>Electric shock hazard!</b>          Never connect up the torque sensor model 8661 if it shows signs of damage incurred in transit. Only ever use the torque sensor model 8661 under the conditions specified in this operation manual.</p>
---	---

Inspect the torque sensor model 8661 carefully for damage. If you suspect that the torque sensor model 8661 has been damaged during shipping, notify the delivery company within 72 hours.

The packaging should be retained for examination by a representative of the manufacturer and/or the delivery company.

The torque sensor model 8661 must be shipped only in its original packaging or in packaging capable of providing an equivalent degree of protection.

## 2.7 Warranty

burster praezisionsmesstechnik gmbh & co kg provides a manufacturer's warranty for a period of 24 months after delivery.

Any repairs required during this time will be made without charge. This does not include damage arising from improper use.

Please note the following when sending the torque sensor model 8661 in for repair:

- If there is a problem with the torque sensor model 8661, please attach a note to the sensor case summarizing the fault.
- Technical specifications subject to change at any time without notice. We also state explicitly that we do not accept liability for consequential damage.
- The torque sensor model 8661 must always be dispatched in suitable packaging.

## 2.8 Conversions and modifications

**Note:** If you open or dismantle the torque sensor model 8661 during the warranty period, this will void the warranty **immediately**.

The torque sensor model 8661 does not contain any parts that are intended to be serviced by the user. Only the manufacturer's own qualified personnel are permitted to open the torque sensor model 8661.

It is forbidden to make any modification to the torque sensor model 8661 without our written permission. We cannot accept liability in the event of such action.

### Our recommendations

- Check the bearings at least once a year to see that they still move freely.
- Replace the special low-friction bearings after a maximum of 20.000 hours of operation. In continuous operation at high speeds it may be necessary to replace the bearings sooner.
- Check cables and connectors annually.
- It is up to you as the user to determine the recalibration interval. We recommend that you check/recalibrate the torque sensor model 8661 after no longer than 12 months. Further details are given in chapter 10 "Calibration and adjustment" on page 70.

# Model 8661

## 2.9 Definitions

### Test side

The test side is that end of the shaft at which you apply the torque being measured to the torque sensor model 8661.

This side normally has the smallest moment of inertia. Torque sensors model 8661 with measuring ranges up to 2 Nm have a smaller and therefore lower-friction ball bearing fitted at this end.

You will see these markings on the measurement end of the torque sensor model 8661:

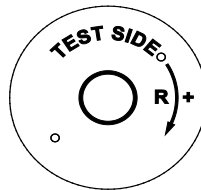

Diagram 1: Test side

### Drive side

The drive side is the opposite end to the measurement end. The torque sensor model 8661 is also mechanically connected at this side.

This side normally has the larger moment of inertia.

You will see these markings on the drive side of the torque sensor model 8661:

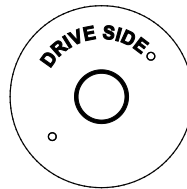

Diagram 2: Drive side

### The torque direction

A torque is clockwise (clockwise torque) if the torque is exerted clockwise **when looking at the measurement end**. In this case you will get a positive electrical signal at the torque sensor model 8661 output.

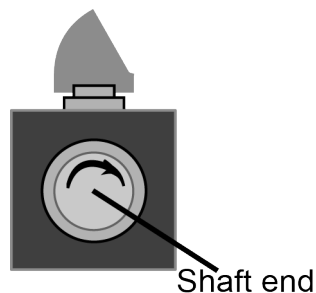

Diagram 3: Torque, clockwise (looking at the test side)

You can use the torque sensor model 8661 to measure both clockwise and counterclockwise torques. If the torque is exerted in an anticlockwise direction (looking at the measurement end), you will get a negative signal at the output.

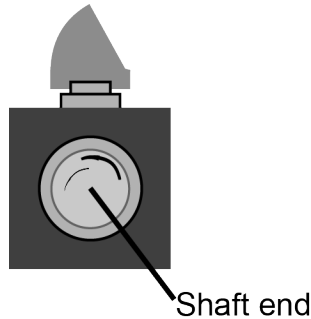

Diagram 4: Torque, anticlockwise (looking at measurement end)

## Sign convention for measuring angular displacement

If the sensor shaft rotates clockwise (**looking at the drive end**), channel A leads channel B by 90°.

If the sensor shaft rotates anticlockwise (**looking at the drive end**), channel B leads channel A by 90°.

## Static and quasi-static torques

Static and quasi-static torques change their value only slowly or not at all. As long as they are below the rated torque, these torques can take any value.

## Dynamic torques

A dynamic torque changes very rapidly and can even oscillate. In this case the frequency of the torque must remain well below the resonant frequency of the mechanical structure as a whole.

**We recommend** that you only measure dynamic torques, if they reach a maximum 70% of the rated torque. The characteristics of your signal analysis and control systems must be taken into account during dynamic testing.

When measuring dynamic torques, take the characteristics of your measuring amplifier into account.

For more information on estimating the resonant frequency and measuring dynamic torques, see chapter 3.4 “Dynamic torques” on page 16.

# Model 8661

## 3 Device design and general information

Specifications as full dimensions, mass and power depend on the version of the torque sensor model 8661. Please refer to the data sheet for specifications.

### 3.1 Mechanical design

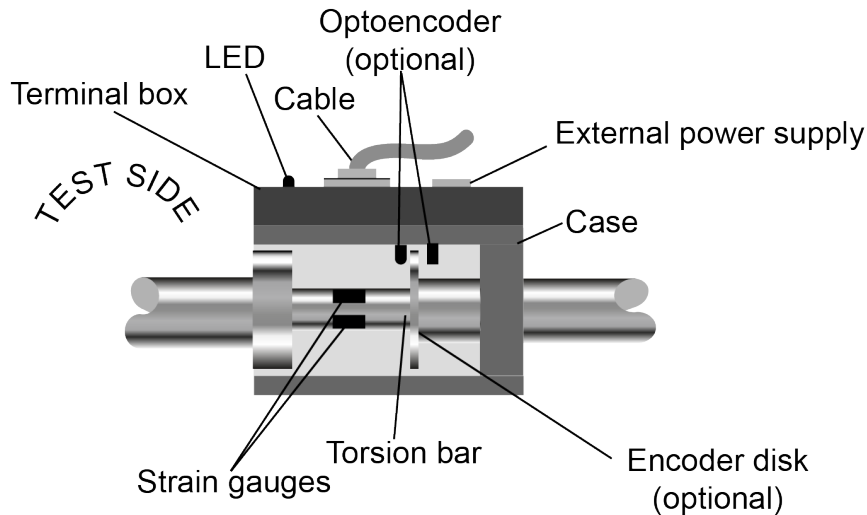

Diagram 5: Design principle

The torque sensor model 8661 essentially consists of three elements:

- Measuring shaft
- Electronics box
- Sensor unit

The measuring shaft is composed of torsion bar, strain gauges, instrumentation amplifier and power and signal transmission components. If the torque sensor model 8661 is fitted with the rotational speed or angular displacement option, an incremental encoder disk is also fitted for measuring rotational speed or angular displacement (see chapter 9.1 "Angle / speed measurement" on page 65).

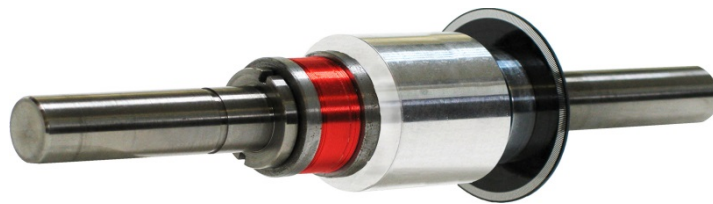

Diagram 6: Shaft from a torque sensor model 8661 with rotational speed and angle measurement

Apart from containing the stator electronics, the electronics box also includes an electrical connecting plug and a socket for an external supply. The sensor unit houses the rotor and two grooved ball bearings.

## 3.2 Principle of operation

Torque deforms the torsion shaft and, as it does so, also elastically and reversibly elongates the strain gauges mounted on the shaft. The electrical resistance of these strain gauges changes proportionally to their elongation.

The torque sensor model 8661 has a total of four strain gauges. These are arranged as a Wheatstone bridge circuit and are supplied with a DC voltage by the electronics. The output voltage from the strain gauges changes in direct proportion to the measured torque. This voltage is amplified before being digitized by an analog/digital converter.

A 16-bit microprocessor processes these digital signals, encodes them and relays them to infrared LEDs, which send the signals to the stator as a serial light signal.

The stator receives this light signal and converts it back into electrical pulses before sending it to another microprocessor. This microprocessor controls a digital/analog converter which generates an analog voltage again (16-bit resolution). This analog voltage is the sensor's measurement signal. It is also proportional to the measured torque.

## 3.3 Static and quasi-static torques

Static and quasi-static torques change their value only slowly or not at all. As long as they are below the rated torque, these torques can take any value.

## 3.4 Dynamic torques

	<h3>NOTICE</h3>
	<p><b>Resonance hazard!</b>            Operating the torque sensor model 8661 or the entire test setup close to its resonant frequency will result in permanent damage. Keep the torque frequency <b>well</b> below the resonant frequency of the mechanical test setup. Limit the peak-to-peak torque variation to 70 % of the rated torque.</p>

**Note:** A calibration carried out for static torques is also valid for measuring dynamic torques, although you must take into account the characteristics of the instrumentation amplifier you are using.



# Model 8661

## Determination of the resonant frequency

The resonant frequency of the entire test setup is related to the sensor's spring constant "c" and to the two moments of inertia "J1" and "J2", each with the connected molding body.

$$f_0 = \frac{1}{2 \cdot \pi} \cdot \sqrt{c \left( \frac{1}{J_1} + \frac{1}{J_2} \right)}$$

$f_0$ : Resonant frequency in Hz

$J_1$ : Moment of inertia 1 in  $\text{kg} \cdot \text{m}^2$

$J_2$ : Moment of inertia 2 in  $\text{kg} \cdot \text{m}^2$

c: Spring constant in  $\text{Nm} / \text{rad}$

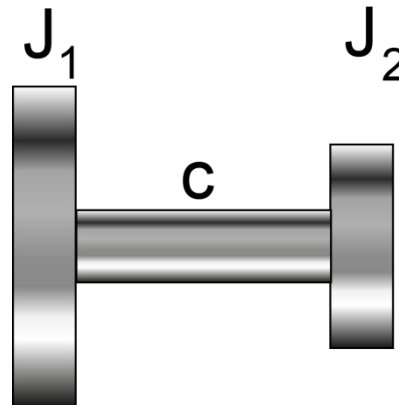

Diagram 7: Resonant frequency model

The Holzer-Tolle method is another way to determine the resonant frequency.

## 3.5 Interference

Possible sources of interference:

- Temperature change
- Temperature gradient
- Vibration
- Spurious forces
- EMC
- Electrical interference
- Magnetic interference
- Angular, axial or radial misalignment (also see chapter 4.1 „Preparing for installation“ on page 18).

**IMPORTANT:** Take suitable measures to counter these sources of interference because otherwise they may cause an incorrect measurement result.

## 4 Installation

### 4.1 Preparing for installation

#### Run-in period

Before fitting the torque sensor model 8661 for the first time, we recommend turning the sensor by hand through several revolutions. This may be needed in order to distribute the lubricant evenly around the roller bearings of the torque sensor model 8661.

#### Shafts

We recommend an H7/j6 shaft fit to ensure correct assembly and good torque transfer.

#### Mounting surfaces

The mounting surfaces for the torque sensor model 8661 or for the optional mounting block must be free of lubricants, particles or burrs.

#### Couplings and misalignments

Even if you align the torque sensor model 8661 precisely, there will always be a minimum misalignment between the shafts. Therefore, when fitting the torque sensor model 8661, always use balanced couplings that allow misalignment correction.

**IMPORTANT:** Before fitting the coupling, check its maximum rated speed.

We recommend using torsionally rigid multi-disk or bellows couplings for correcting misalignments. Always use the full specified clamping length of the coupling.

#### Different kinds of misalignments

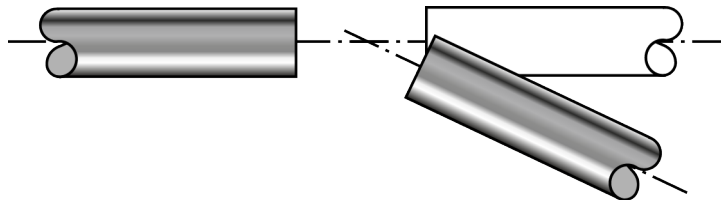

Diagram 8: Angular misalignment

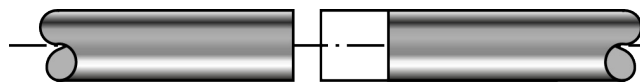

Diagram 9: Axial misalignment, e.g. due to thermal expansion

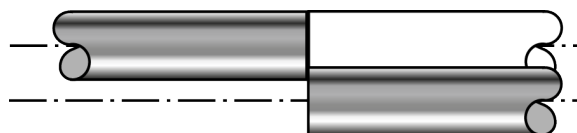



Diagram 10: Radial misalignment

Both angular and axial misalignments can be corrected using “half-couplings”. Full couplings are needed, however, to correct any radial misalignment. To find suitable couplings refer to the datasheet 8690 visit [www.burster.com](http://www.burster.com).

# Model 8661

## 4.2 Mechanical installation

### 4.2.1 Installation using mounting block

	<h2 style="margin: 0;">NOTICE</h2>
<p><b>Avoid excessive torques, bending moments or axial forces!</b>          Excessive torques, bending moments or axial forces may damage the torque sensor model 8661. Connect the electrical cable to the torque sensor model 8661 during fitting and monitor the measurement signal. This signal must remain within the permitted range.          Support the torque sensor model 8661 during fitting to make sure it does not drop, and do not resort to hammering to aid installation.</p>	

We recommend fitting the torque sensor model 8661 with an associated mounting block, model number 8661-Z00X. Mounting blocks have the advantage of an extra locating pin to help align the torque sensor model 8661 easily. If the torque sensor model 8661 needs to be removed temporarily from the setup, the mounting block avoids any time-consuming realignment when it is refitted.

In this case you will need to fit **balanced full couplings** at both shaft ends.

For suitable mounting blocks, see data sheet 8661. You'll find suitable couplings on datasheet 8690.

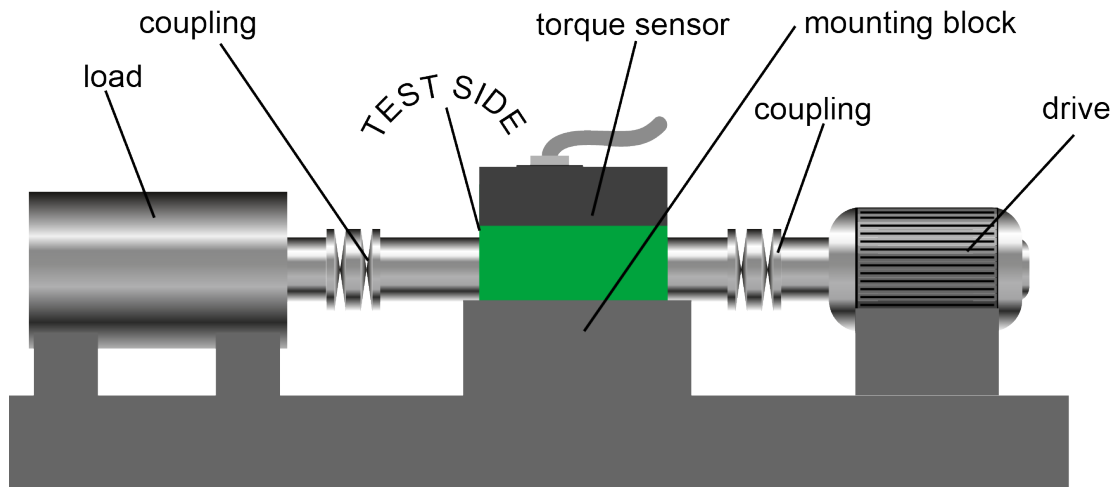

Diagram 11: Schematic measuring arrangement, fitted with a mounting block

## Mounting instructions



### This is how it works

1. Clean and de-burr the shafts and hubs and any other contact and mounting surfaces on your components. At time of fitting, there must be no foreign matter, burrs or lubricants on these components.
2. Fit the torque sensor model 8661 on the mounting block. Use the locating pin to centre the torque sensor model 8661 on the mounting block then screw-fasten the sensor to the block.
3. First roughly align the mounting block. Initially only loosely tighten the assembly bolts on the mounting block.
4. Fit the full couplings on the shaft ends of the torque sensor model 8661. Always use the entire clamping length of these couplings. If possible, fit the torque sensor model 8661 starting from the test side. Initially only loosely tighten the fixing screws on the couplings.
5. Now align the mounting block precisely. This avoids any unnecessarily high reaction forces, while also reducing the load on the coupling and any spurious forces acting on the torque sensor model 8661. At low rotational speeds ( $< 2000 \text{ min}^{-1}$ ), it is usually sufficient to align the coupling using a straight edge in two perpendicular planes. However, we recommend using a dial gauge or laser to align the coupling and shaft ends.
6. Once you have fitted all shafts into the coupling hubs and correctly aligned all parts, tighten the fixing bolts on the mounting block.

**IMPORTANT:** Make sure you do not move the mounting block when tightening.

7. Tighten each coupling to hold the shaft firmly, making sure you observe the following requirements:
  - a. Start on the side that is easier to turn. Usually this will be the measurement side.
  - b. Do not exceed the permitted torques. Use a torque wrench.
  - c. Hold screws from the other end when tightening.
  - d. Be aware of the maximum forces that you apply. The resultant torques must lie below the rated torque of the torque sensor model 8661. The relevant values are listed in the data sheet.

# Model 8661

## 4.2.2 Free-floating installation

	NOTICE
	<p><b>Beware of vibrations!</b>          Operating the overall system close to its natural resonance frequencies will result in permanent damage on the torque sensor model 8661. Make sure, that <b>no</b> resonance occurs throughout the entire speed range.</p>

The torque sensor model 8661 is positioned between two balanced half-couplings. Installed in this way, the torque sensor model 8661 and the two half-couplings form a full coupling. Hence it helps to compensate for the inevitable axial offset between the mechanical connections.

	NOTICE
	<p><b>Avoid excessive torques, bending moments or axial forces!</b>          Excessive torques, bending moments or axial forces may damage the torque sensor model 8661. Connect the electrical cable to the torque sensor model 8661 during fitting and monitor the measurement signal. This signal must remain within the permitted range.          Support the torque sensor model 8661 during fitting to make sure it does not drop, and do not resort to hammering to aid installation.</p>

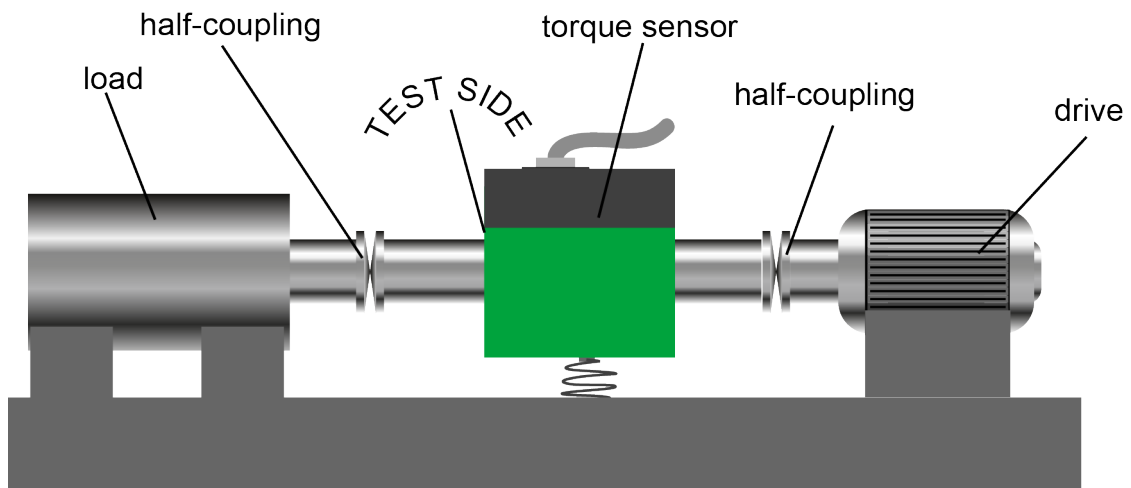

Diagram 12: Schematic measuring arrangement with free-floating installation

## Mounting instructions



### This is how it works

1. Clean and de-burr the shafts and hubs and any other contact and mounting surfaces on your components. At time of fitting, there must be no foreign matter, burrs or lubricants on these components.
2. Fit the half-couplings on the shaft ends of the torque sensor model 8661. Always use the entire clamping length of these couplings. If possible, fit the sensor starting from the test side. Initially only loosely tighten the fixing screws on the couplings.
3. Fit the torque sensor model 8661 onto the shafts of the torque apparatus without tightening the couplings at this stage. Always hold the torque sensor model 8661 firmly in your hand to avoid any inadmissible bending moments on the sensor shaft!
4. Align the torque sensor model 8661 precisely. This avoids any unnecessarily high reaction forces, while also reducing the load on the coupling and any spurious forces acting on the torque sensor model 8661. At low rotational speeds ( $< 2000 \text{ min}^{-1}$ ), it is usually sufficient to align the coupling using a straight edge in two perpendicular planes. However, we recommend using a dial gauge or laser to align the coupling and shaft ends.
5. Once you have fitted all the shafts in the coupling hubs and correctly aligned all parts, tighten each coupling to hold the shaft firmly, making sure you observe the following requirements:
  - a. Start on the side that is easier to turn. Usually this will be the measurement side.
  - b. Do not exceed the permitted torques. Use a torque wrench.
  - c. Hold screws from the other end when tightening.
  - d. Be aware of the maximum forces that you apply. The resultant torques must lie below the rated torque of the torque sensor model 8661. The relevant values are listed in the data sheet.
  - e. Make sure you support the torque sensor model 8661 against reaction moments, which may otherwise cause the sensor to rotate. It is not admissible to use the cable connection for this purpose.

# Model 8661

## 5 Torque sensor model 8661 with analog connection

### 5.1 Electrical connection

#### 5.1.1 Power supply

The operating voltage is supplied to the standard model of the torque sensor model 8661 via the connecting plug. Alternatively, it is also possible to provide an external supply via the socket.

	<b>CAUTION</b>
	<p><b>Never connect power via both connections simultaneously.</b>          If the evaluation device were to supply by 15 VDC to the 12-pin built-in plug at the same time as the connected mains adapter supplied 24 V to the jack socket – which shouldn't happen – this could destroy the evaluation device.</p>

#### 5.1.2 Connector pin assignments (standard sensor, 1 range)

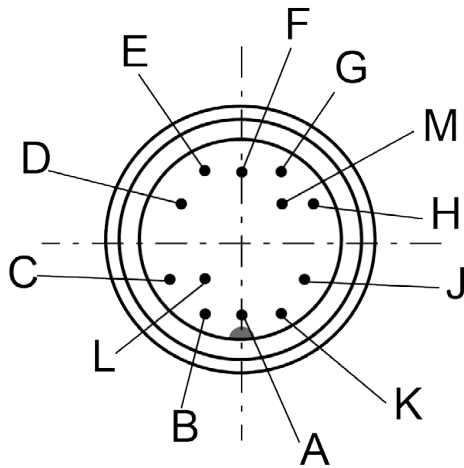

Diagram 13: View of the plug

12-pin plug	Function
A	Not used
B	Angular displacement, channel B (option)
C	Torque, voltage output
D	Torque, output ground
E	Sensor supply/angle of rotation, ground
F	Sensor supply, voltage
G	Angular displacement, channel A (option)
H	Not used
J	Sensor supply, ground
K	Control input
L	Not used
M	Not used

## 5.1.3 The connections in detail

### Voltage output for torque

This consists of an operational amplifier with a downstream low pass filter.

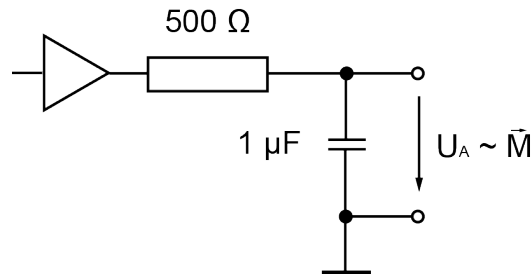

Diagram 14: Voltage output for torque

The connected evaluation circuit should be high impedance ( $> 10 \text{ M}\Omega$ ). The reference is the potential separated torque output ground. You can connect this to the supply ground on the evaluation device.

### TTL output for rotational speed / angular displacement

Both channels are designed the same way. A TTL signal is available directly, without additional external circuitry. The reference here is the supply ground. You can connect this to the torque output ground on the evaluation device.

**Note:** In conjunction with the internal pull-up resistor, the cable capacitances form a low-pass filter. You should therefore use the shortest possible, high quality, low capacitance cable for maximum transmission quality.

### Open collector output for rotational speed and angular measurement

	<h2>NOTICE</h2>
	<p><b>Danger of excessive heating!</b>          When connected to a voltage source, the torque sensor model 8661 overheats. This overheating will permanently damage the torque sensor model 8661.  <b>Always</b> use a pull-up resistor in the voltage source connection.</p>

**Note:** The PLC input is designed for positive logic. It is **not** suitable for American PLCs.



# Model 8661

Here the external voltage is superimposed on the internal voltage source. As a result, for example, you can connect the torque sensor model 8661 directly to a PLC input with positive logic (not for American PLCs). Using the same connection method you can reduce problems with transmission quality with longer cables.

**Note:** Pay attention to the maximum current and voltage values. The external pull-up resistor dissipates a considerable amount of power.

Guide value 12 V / 1 k $\Omega$  (0.5 W).

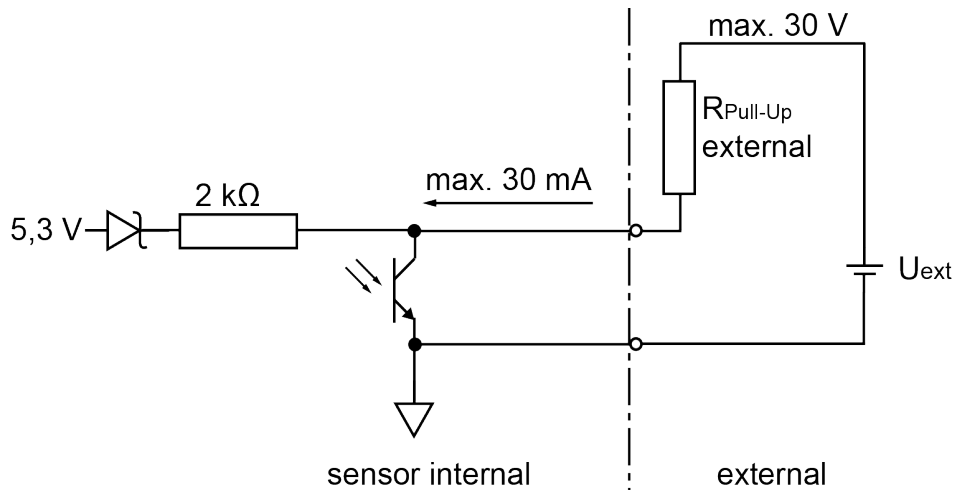

Diagram 15: Open collector output

## TTL output on 3.3 V or other logic

The diagram shows adaptation for 3.3 V logic. For other logic levels, appropriate Zener diodes need to be used.

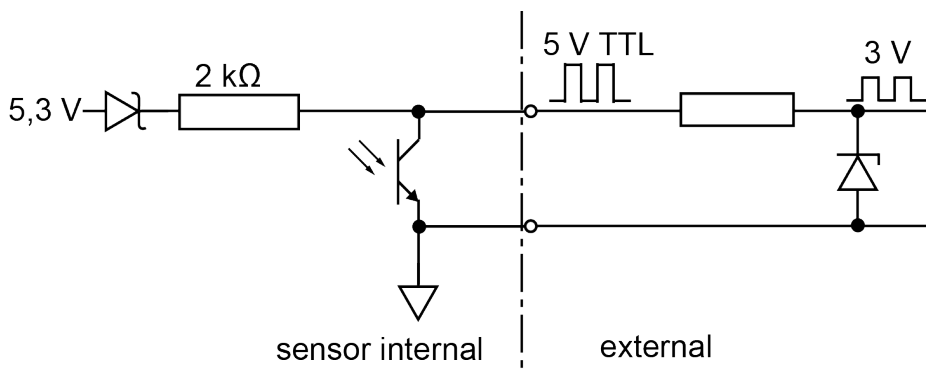



Diagram 16: Resistance 10 k $\Omega$ , Zener diode 3.3 V

## Longer transmission paths up to approx. 10 m

	CAUTION
	<p><b>Danger of excessive heating!</b>          When connected to a voltage source, the torque sensor model 8661 overheats. This overheating will permanently damage the torque sensor model 8661.  <b>Always</b> use a pull-up resistor in the voltage source connection.</p>

Depending on the cable type, cable cross-section, cable length and frequency, you may need to select a somewhat smaller pull-up resistor.

Pay attention to the maximum current and voltage values, and to the fact that considerable power is dissipated at the pull-up resistor and Zener diode.

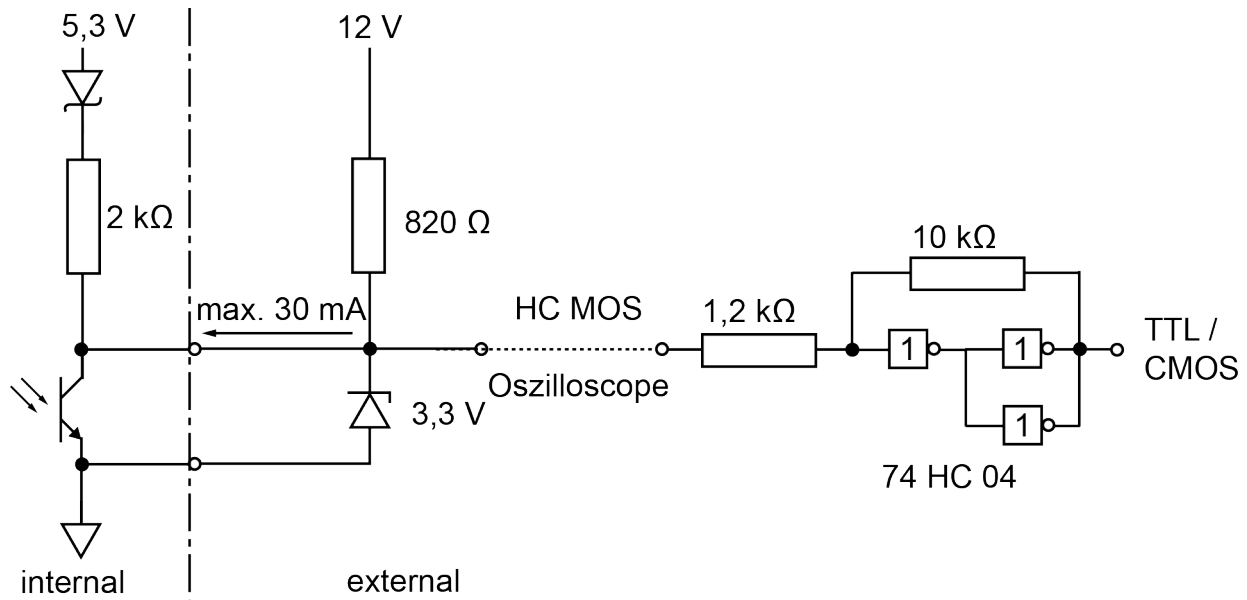

Diagram 17: Longer transmission paths

### 5.1.4 Running cables

Electrical and magnetic fields can often be picked up by the test leads, causing interference. Such interference mainly stems from power cables running parallel to the test leads, but can also be caused by contactors, thyristor controllers, variable frequency drives and electric motors in the vicinity. Ensure these are a sufficient distance away and route test leads through a grounded steel pipe if necessary.

Galvanic interference can also occur, particularly if the measurement chain is grounded at multiple points creating differences in electrical potential. These ground loop currents can be avoided by either disconnecting the double grounding or bypassing it by running a particularly low-resistance ground cable (6-10 mm<sup>2</sup>) parallel to the test lead.

# Model 8661

The main points to remember are:

- The torque sensor model 8661 must be grounded via its assembly bolts.
- Run the cable loosely and with enough play in the cable to allow for any movement.
- Avoid any tension on the connecting plug.
- Avoid excessive lengths. If that is not possible, snake the cable. This will reduce the effective induction area.

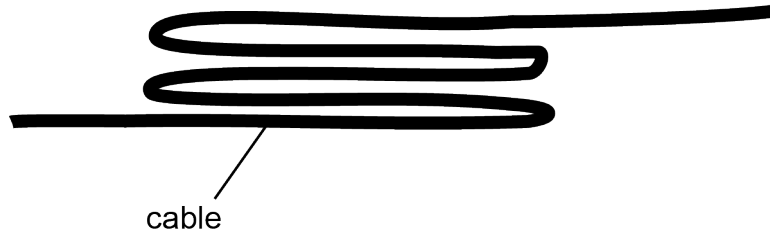

Diagram 18: Layout of a cable with excess length

- Locate the torque sensor model 8661, cable and measuring instrument outside the field of high-energy equipment. These include transformers, motors, contactors, frequency converters and so forth. Otherwise the electromagnetic fields from such equipment will act with their full effect on the measuring chain, causing incorrect measurements.
- Lay the measuring lines separately from high-power cables. If the measuring lines are laid parallel to such cables, interference will be coupled in inductively and capacitively.

**Note:** In some cases it is helpful to pull an extra shield as additional protection over the measuring cable, or to lay the cable in a metal tube or pipe, which must be grounded.

## 5.1.5 Extension cables

- Always use shielded, low-capacitance cables.
- We recommend using cables supplied by burster präzisionsmesstechnik gmbh & co. kg. These cables meet the requirements.
- For extension cables, make sure that the connection is flawless with good insulation.
- Make sure that cable cross-section is sufficient.

**Note:** If you use extension cables it is not necessary to recalibrate the torque sensor model 8661. However, you will need to adjust the entire measuring chain.

**IMPORTANT:** If a burster cable of type 99540-000F-05200XX is ordered with the sensor, a ceramic capacitor is supplied with the cable. This ceramic capacitor is needed only with torque sensors that include the angle/speed measurement option. The effect of the ceramic capacitor is to suppress potential cross-talk from the angular displacement/rotational speed output to the torque output. Connect the ceramic capacitor between the torque output and torque GND.

## 5.2 Measurement

### 5.2.1 Switching on



This is how it works

1. Apply the operating voltage to the torque sensor model 8661.
2. Some models of the torque sensor model 8661 go through a self-test mode lasting 4 seconds after power-up. Once the self-test has finished, all the LEDs light up solidly for about 1 s.
3. As soon as they go dark again, the torque sensor model 8661 switches into its normal operating state. It is now ready for use.

### 5.2.2 Status display (standard sensor, 1 range)

Status display	Cause / meaning
Green LED flashes	Torque is less than 5 % of the rated torque.
Green LED lit	Torque is between 5 % and 90 % of the rated torque.
Yellow LED lit	Torque is between 90 % and 100 % of the rated torque.
Red LED flashes	<b>Overload!</b> Torque is between 100 % and 150 % of the rated torque.
Red LED lit	<b>Overload!</b> Torque is greater than 150 % of the rated torque.
LEDs flash: green-yellow-red	<b>Fault!</b> Please contact us. (In addition to the LEDs you can measure an alternating signal at the output: 5 Hz, 0 and 10 V.)

### 5.2.3 Speed limits

	<h2>NOTICE</h2>
	<p><b>Excessive speeds will damage the torque sensor model 8661!</b> Excessive forces arise above the maximum speed. Always operate the torque sensor model 8661 below the maximum speed (see data sheet).</p>

### 5.2.4 Check function

When a voltage  $U_b$  is applied to the test input, the torque sensor model 8661 outputs a signal of exactly 10.000 V at the analog output.

# Model 8661

## 6 USB version of the torque sensor model 8661

### 6.1 Electrical connection

The USB socket on the torque sensor model 8661 is fitted in the factory with a protective dust cap. Before putting the torque sensor model 8661 into use, this cap must be levered off with a suitable tool without being damaged. It does not need cutting off.



This is how it works

1. Carefully release the protective cap using a pointed tool.



- 2.
3. Take the cap off the USB socket.



- 4.
5. Connect the torque sensor model 8661 to a computer by a USB cable.
6. It is essential that you follow the guidance given in chapter 6.1.1 "Power supply" on page 30.
7. Some models of the torque sensor model 8661 go through a self-test mode lasting 4 seconds after power-up. Once the self-test has finished, all the LEDs light up solidly for about 1 s.
8. As soon as they go dark again, the torque sensor model 8661 switches into its normal operating state. It is now ready for use.

## 6.1.1 Power supply

After the torque sensor model 8661 is connected to the USB port, the sensor identifies itself as a “high power device”. In this case the device draws 495 mA from the USB port. Usually this is not a problem for desktop PCs.

For laptops, however, several USB ports may share one power supply that is additionally loaded by other connected USB devices (mouse etc.). Therefore under some circumstances the torque sensor model 8661 may be supplied with too little power and cannot register its presence. In this case, you need to connect the torque sensor model 8661 to the laptop via an active USB hub.

**Note:** Actual power consumption is typically:  $P = 5\text{ V} * 0.35\text{ A} = 1.75\text{ VA}$ .

## 6.1.2 USB 2.0 pin assignment

The USB interface complies with the USB 2.0 standard and the pin assignment is as usual. The built-in connector on the torque sensor model 8661 is a “mini B USB” plug.

Pin	Name
1	+ 5 V
2	Data -
3	Data +
4	ID (not used)
5	GND

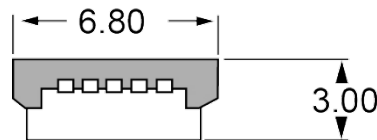

Diagram 19: Mini B USB [mm]

The connector fitted on the supplied cable is a “type A USB” plug.

Pin	Name
1	+ 5 V
2	Data -
3	Data +
4	GND

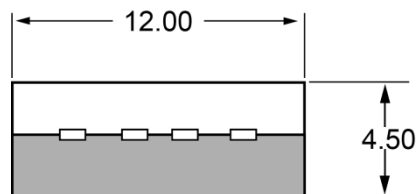

Diagram 20: A USB [mm]

# Model 8661

## 6.1.3 Ground connection

The common ground connection “Digital Ground GND” is shared by:

- USB plug casing
- Shield
- Sensor housing
- Protective earth.

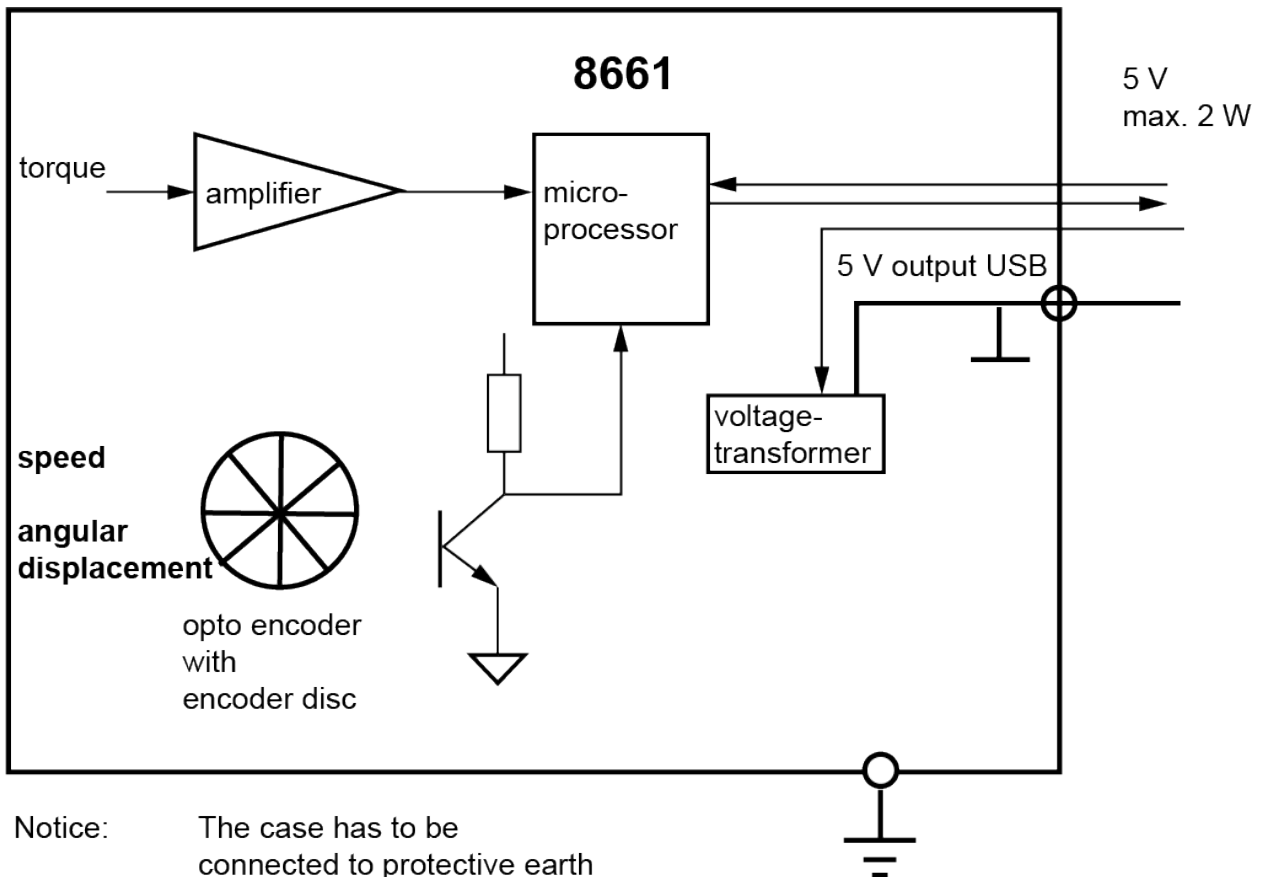

Notice: The case has to be connected to protective earth

Diagram 21: Ground connection

## 6.1.4 Wiring

The main points to remember are:

- The torque sensor model 8661 must be grounded via its assembly bolts.
- The USB cable length should not exceed 2 m. For longer cables it may be necessary to connect an active USB hub in the cable link to avoid losing the USB connection.

## 7 Software DigiVision

The DigiVision configuration and analysis software is needed in order to be able to use the USB version of the torque sensor model 8661. A basic version of DigiVision, product number 8661-P001, is supplied with the USB version of the torque sensor model 8661. Advanced measurement functions for particular test requirements are available as a software upgrade (see chapter 8.3 “Software version & licensing” on page 61).

DigiVision lets you display and record measurement data from up to 32 measurement channels (only for software version 8661-P200). DigiVision can also be used to configure a wealth of parameters for the USB version of the torque sensor model 8661.

### 7.1 Device list / device detection

The device list in DigiVision lets you manage the sensors on the computer. In order to use DigiVision, you must enter a valid licence key when you first run the software. For further details please refer to chapter 8.3.4 “Licensing” on page 64.

If the torque sensor model 8661 has been used before with DigiVision on your computer, the device is normally detected automatically.

Otherwise you may need to add the torque sensor model 8661 to the device list. If the torque sensor model 8661 is not displayed, run the device detection process.



**This is how it works**

1. Open DigiVision.
2. Go to „File“ > „Find devices...“.

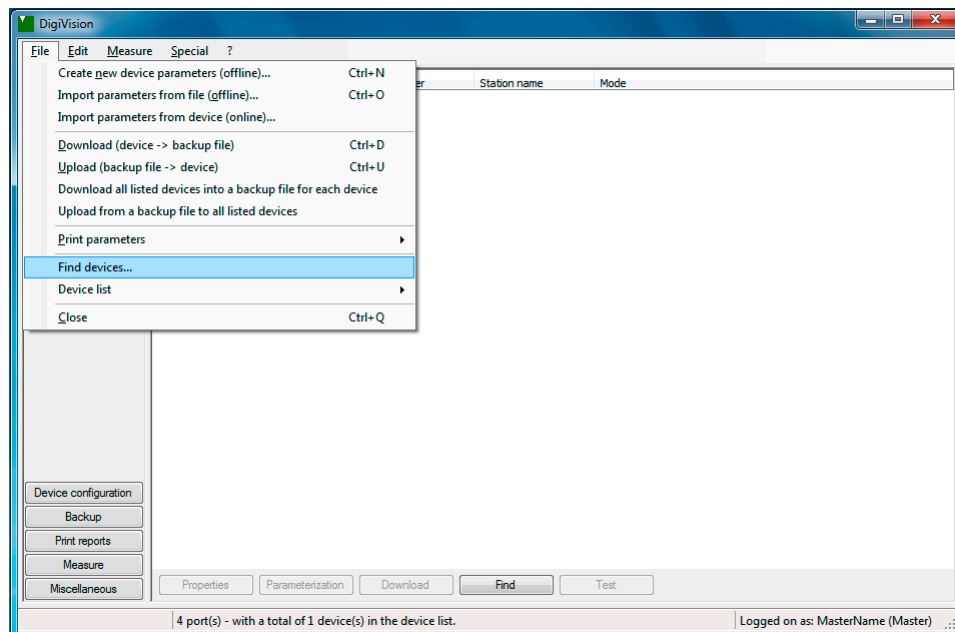



# Model 8661

- As soon as the torque sensor model 8661 is detected, it appears under its port.

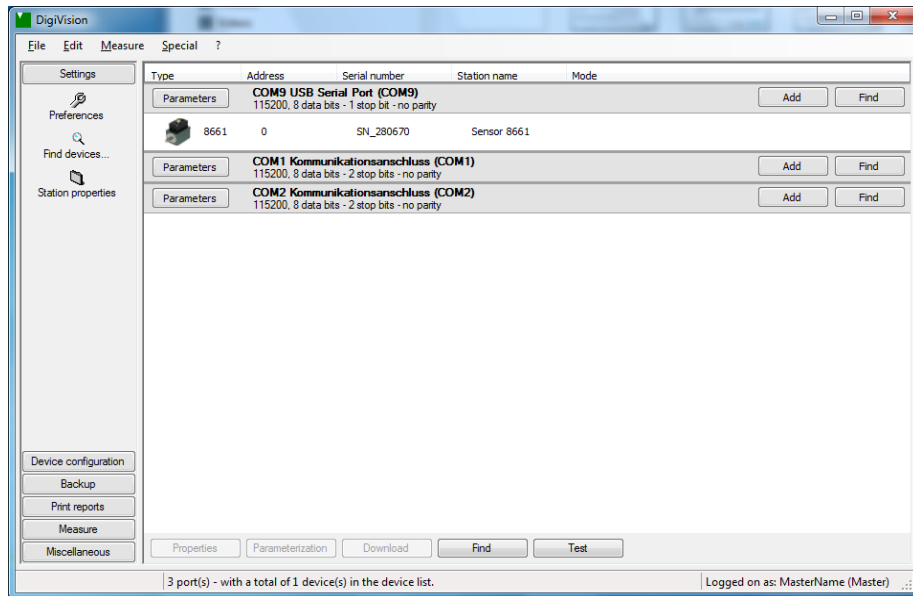

## 7.2 Device settings

You can access the “Device settings” menu from the DigiVision device list.



This is how it works

- Open the device list in DigiVision.
- Select the torque sensor model 8661 and click “Parameterization”.

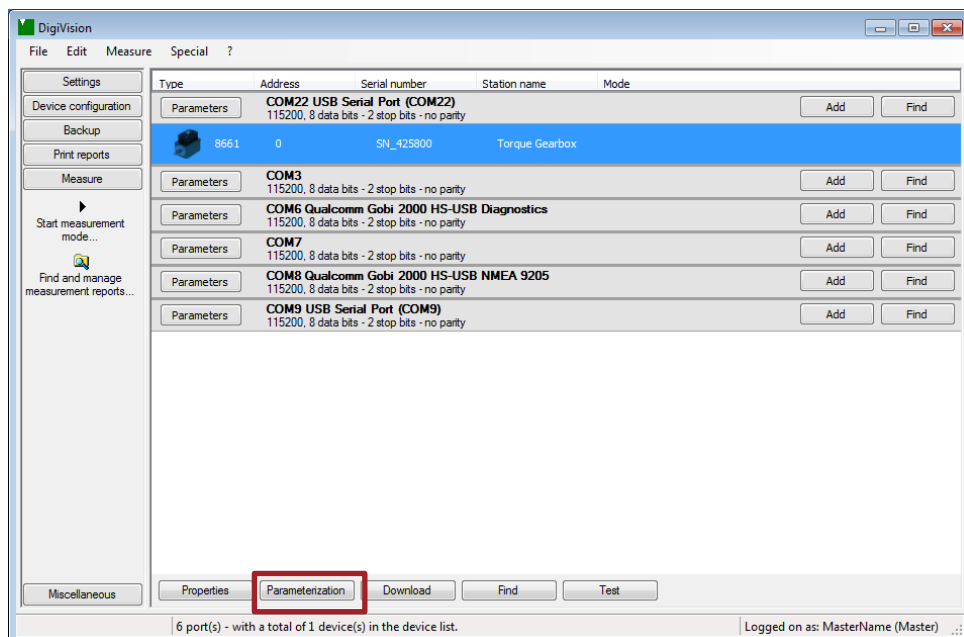

- You can now configure the sensor-specific settings.

## 7.2.1 Settings

In the “Settings” tab you can specify the dimensional units and conversion factors to be used for the relevant measurement channels. It is worth choosing sensible units that suit the measurement variables, because otherwise errors may appear in the measured value display.

If the torque sensor model 8661 includes the speed/angle measurement option, you can switch between these two forms of measurement in this menu.

If the torque sensor model 8661 is the optional dual-range version, you can also select here the measurement range you require. Chapter 9.2 “Dual-range sensor” on page 67 contains further information on dual-range sensors.

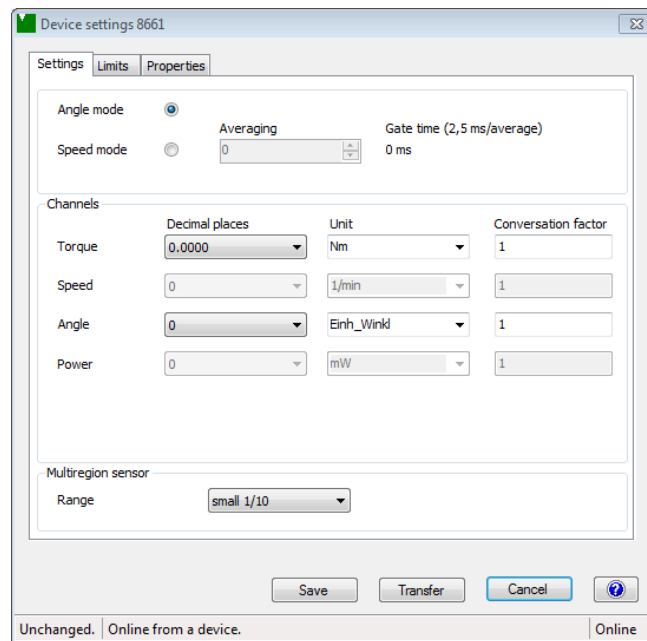

Diagram 22: Settings

# Model 8661

## 7.2.2 Limits

The “Limits” tab is where you can set the torque sensor model 8661 limits you require. Select the level for the limit, the channel reference for this limit and whether you wish to monitor the measurement signal for  $\geq$  or  $\leq$ .

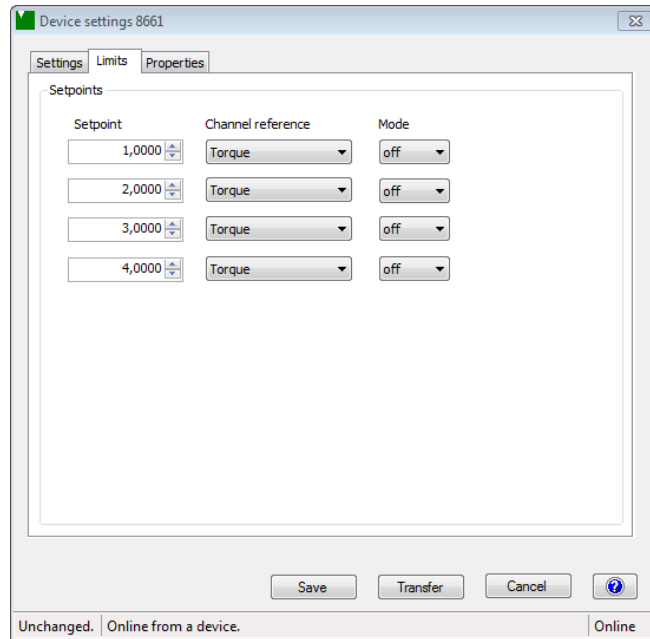

Diagram 23: Limits

## 7.2.3 Properties

The “Properties” tab contains information about the torque sensor model 8661 being used. This is where you can find the software version, device type, serial number, device option and calibration date. You can also add comments for documentation purposes.

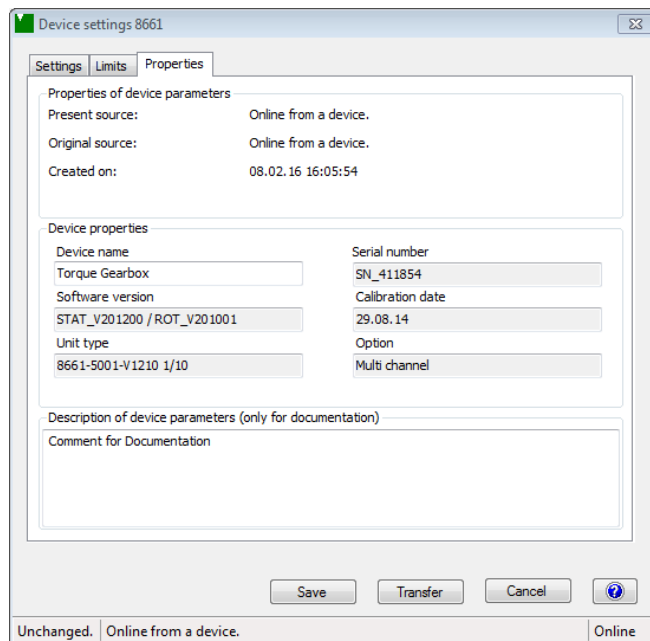

Diagram 24: Properties

## 7.3 Properties, measurement rate etc.

You can use the “Properties” button to make additional general settings. For instance you can set here the measurement rate for the torque sensor model 8661.



This is how it works

1. Open the device list in DigiVision.
2. Select the torque sensor model 8661 and click “Properties”.

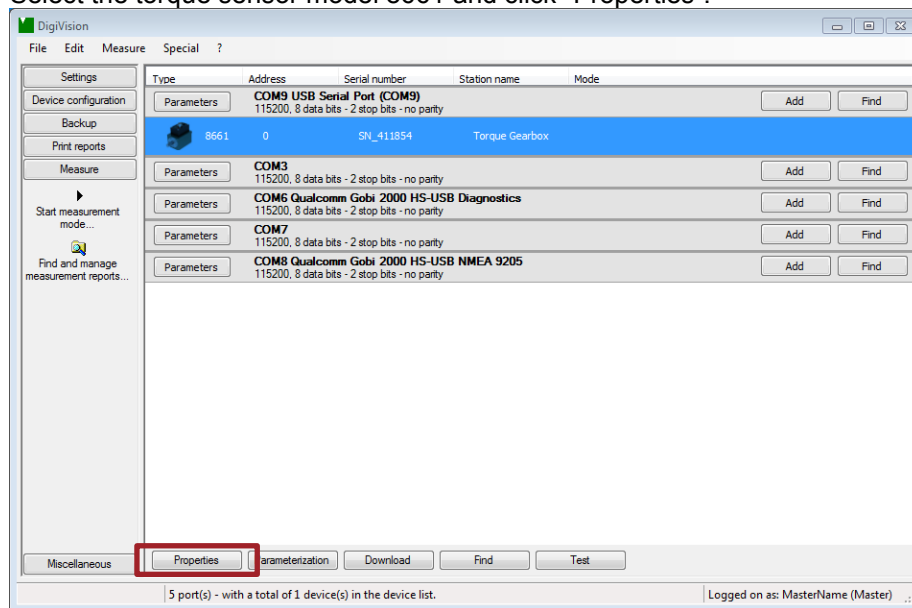

3. You can now configure additional general settings.

### 7.3.1 General information

You can use the “Properties” button to make additional general settings. For instance you can set here the station name for the torque sensor model 8661.

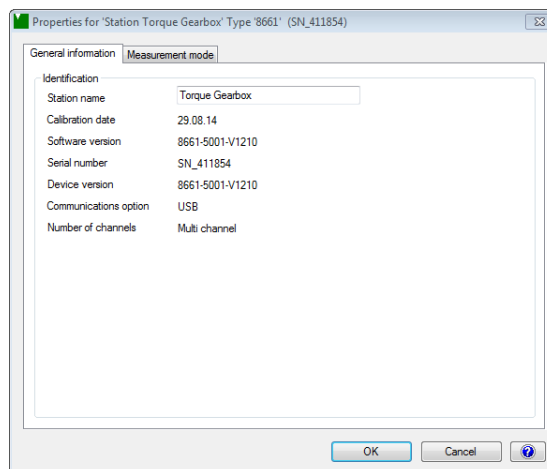

Diagram 25: General information

# Model 8661

## 7.3.2 Selecting the measurement rate

Two different acquisition modes are available. Different measurement rates (sampling rates) can be selected depending on the acquisition mode.

### Normal

Measurement rates of between 0.1 and 20 measurements per second are possible here.

### SPOM (Speed optimized POLLing Mode)

Measurement rates of between 0.1 and 1000 measurements per second are possible here.

### Angle display

The “Measurement mode” tab also lets you set how you want to display the (optional) angle reading: from 0 to 360° or continuously without limit.

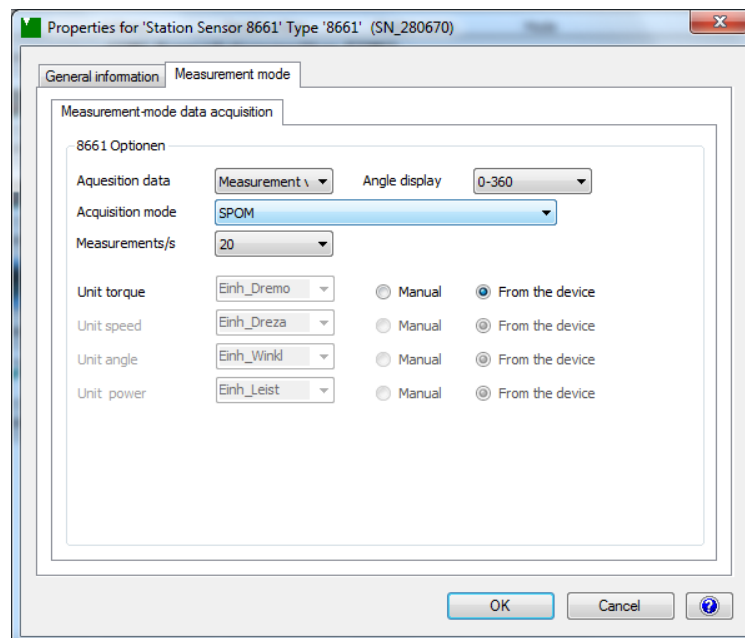

Diagram 26: Selecting the measurement rate and acquisition mode

## 7.4 Measurement-mode settings

In DigiVision, numerous different settings can be made for the measurements. You can access the “Basic configuration” menu directly from the “Measurement mode” function.



This is how it works

1. Open the device list in DigiVision.
2. Select the torque sensor model 8661 and click „Start measurement mode...”.

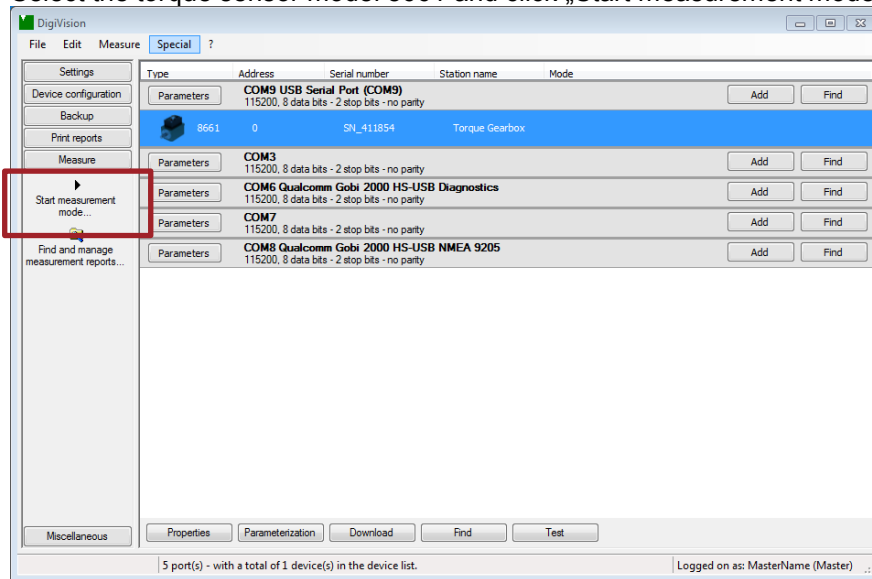

3. Press the “Options” button. This opens the “Basic configuration” window.

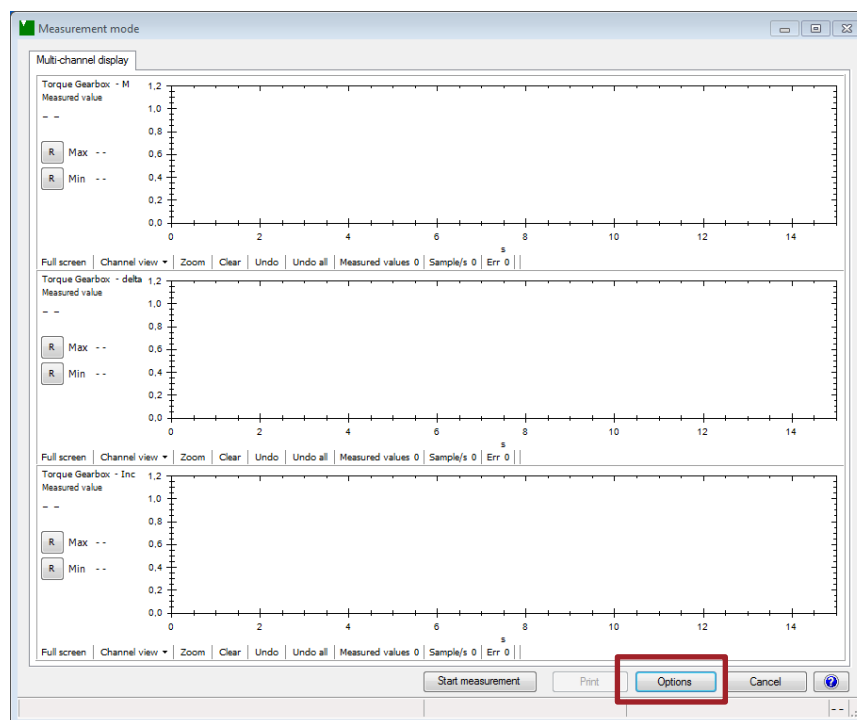

# Model 8661

## 7.4.1 Basic configuration

In the “Basic configuration” tab you can specify how many channels you wish to display. You can also make various settings here for the display and presentation of the measurement curve.

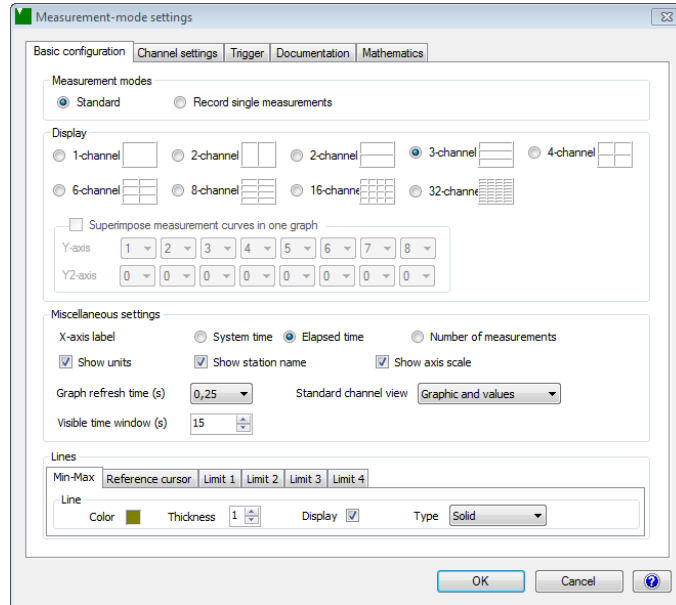

Diagram 27: Basic configuration

## 7.4.2 Channel settings

The “Channel settings” tab is where you can set specific parameters for each measurement channel.

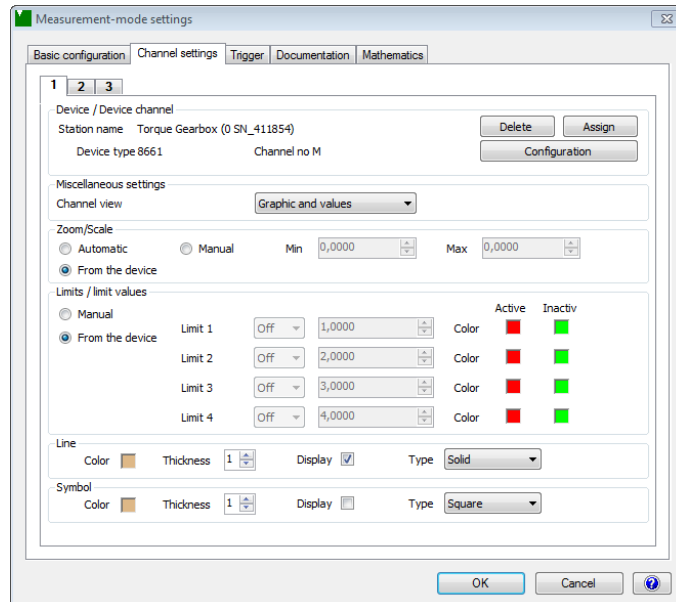

Diagram 28: Channel settings

The default setting is to adopt the parameters from the torque sensor model 8661, although you can also make manual changes to any parameter. You can also define here the limits, measurement-curve colours and the colours and shapes of the symbols that can be shown in the graphs. You make these settings separately for each measurement channel.

## 7.4.3 Trigger

Measurement can also be stopped using a trigger with a suitable stop condition.

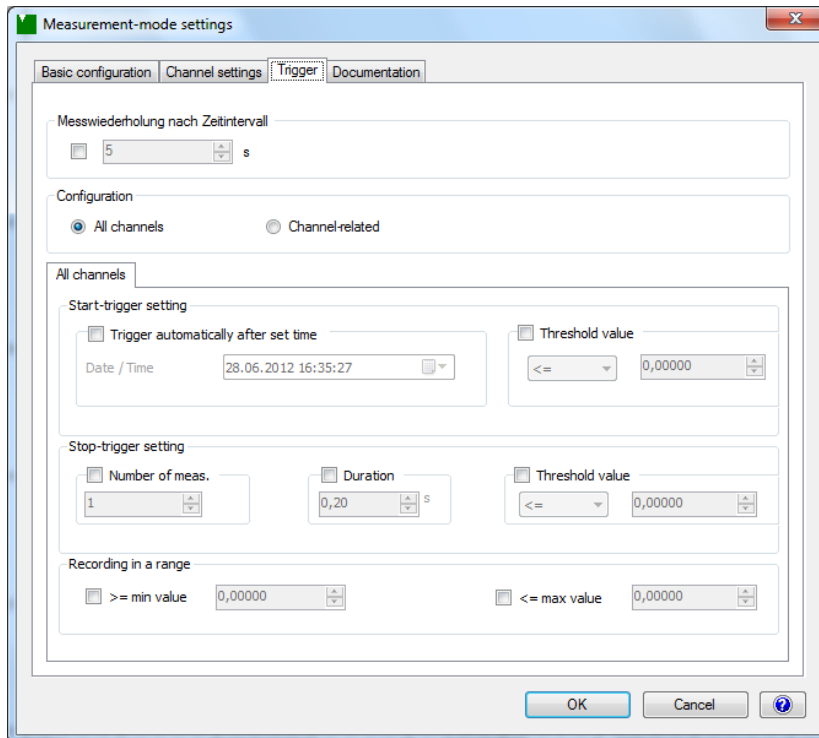

Diagram 29: Trigger settings

### Repeat measurement after time interval

You can use the “Repeat measurement after time interval” setting to specify a time interval after which a repeat measurement shall take place following the end of a measurement process. You can configure the settings to apply to all channels or each channel individually.

### Start-trigger setting

Here you can define the start condition.

### Stop-trigger setting

Here you can define the stop condition.

### Recording in a range

You can use this setting to specify the range of values within which a measurement shall take place.



# Model 8661

## 7.4.4 Documentation

Various documentation settings are available here. For instance you can define various count settings, which can be common to all channels or apply to specific channels. You can also enable/disable the documentation setting.

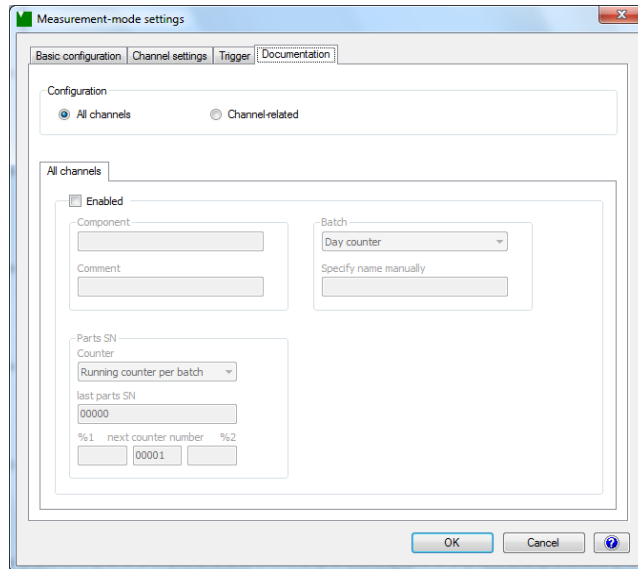

Diagram 30: Documentation settings

## 7.5 Display

The measurement curves are displayed in a line graph separately for each measurement channel. The measured values are plotted against measurement time in this graph.

You have various zoom and display options available to gain a better view. For instance you can show/hide measurement channels.

Maximum and minimum values (Max, Min) are shown in the area to the left of the graph. You can reset these values using the "R" buttons.

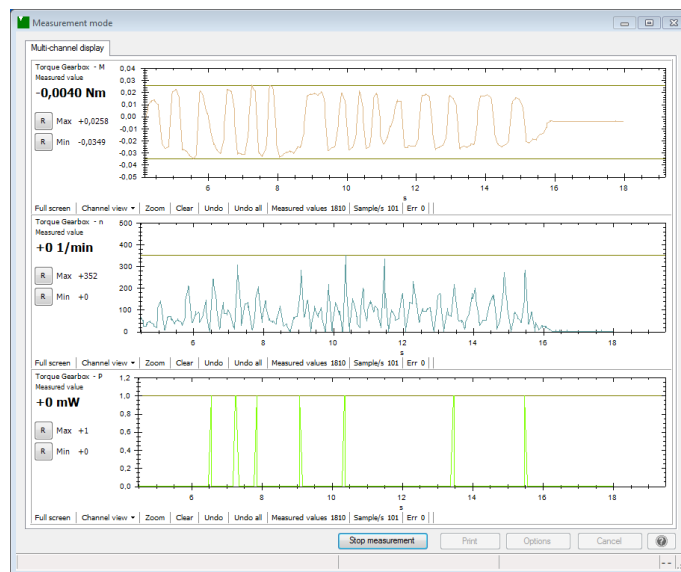

Diagram 31: Display showing the measurement curves for torque, speed and mechanical power (8661-P001)

In the multi-channel software version 8661-P100, you can switch between different views.



This is how it works

1. Click on “full-screen” to get a larger view of the measurement curve. This enlarges the individual graph to full-screen size during the measurement process.

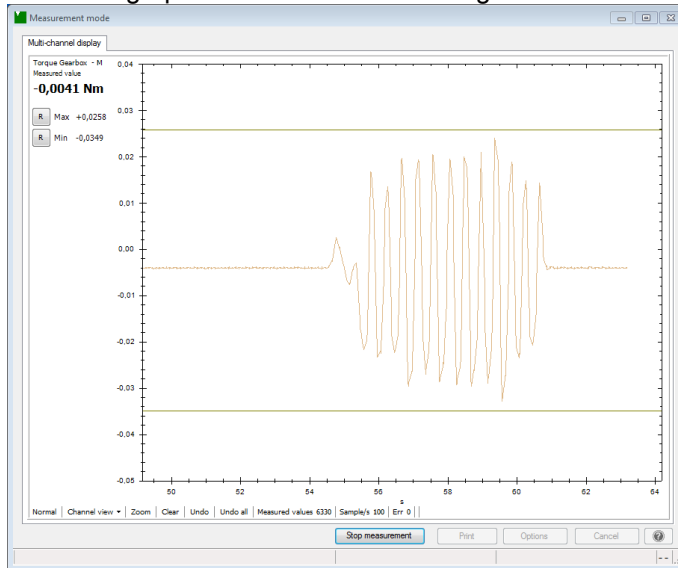

2. Click on “Normal” to revert to the standard view.

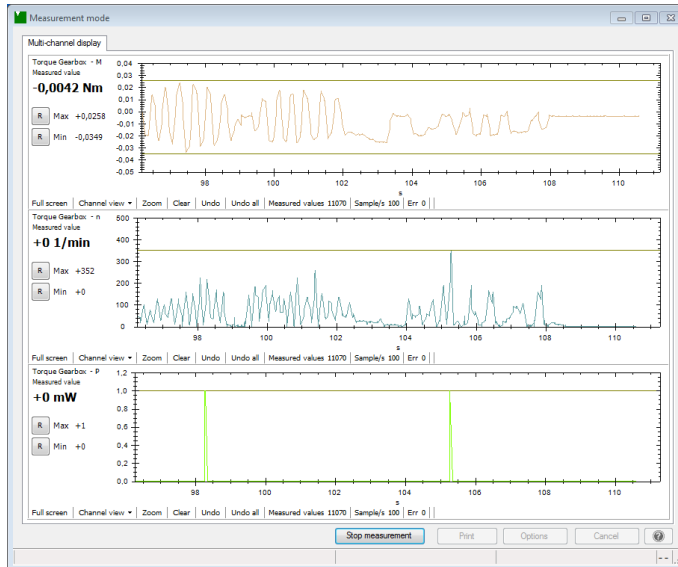

# Model 8661

## 7.6 Start / stop a measurement

To start a DigiVision measurement based on a connected torque sensor model 8661 or another USB device, follow the steps below:



This is how it works

1. Select the torque sensor model 8661 from the device list and click “Start measurement mode...” under “Measure” in the left-hand menu bar.

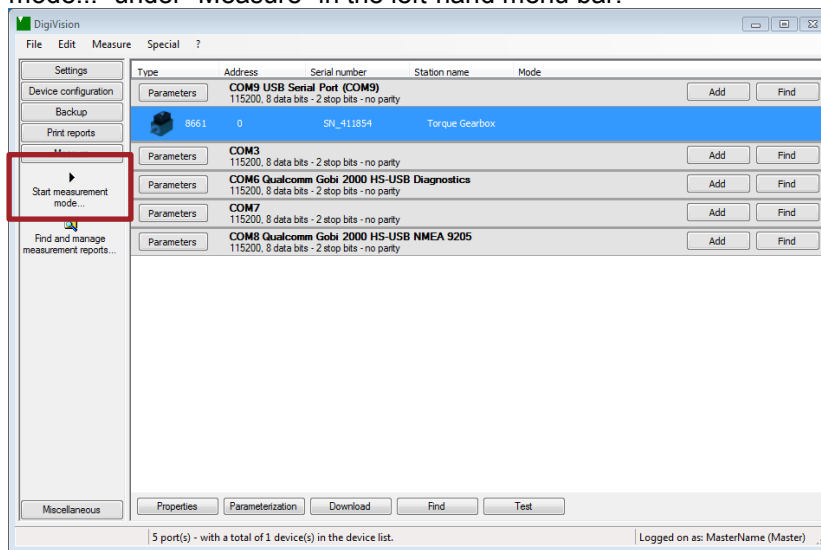

2. Click “Start measurement” or press [F5].

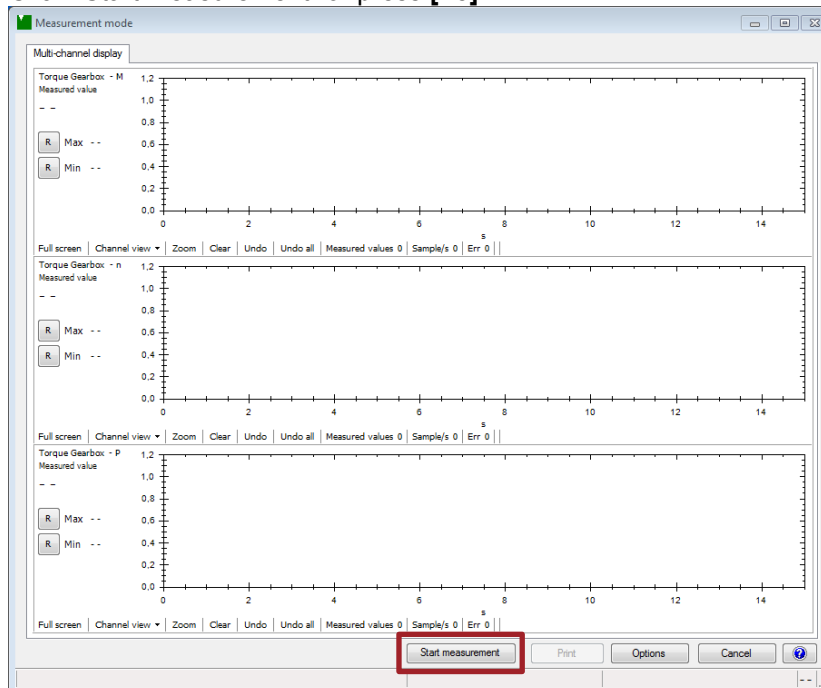

3. During the measurement process, the instantaneous measured value and minimum and maximum values are displayed and updated at the set measurement rate. Click on "R" to reset the maximum and minimum values.

- To stop the measurement, click “Stop measurement” or press **[F8]**. The measurement can also be stopped using a trigger with a suitable stop condition. For further information about the trigger function, please refer to chapter 7.4.3 “Trigger” on page 40.

## 7.7 Measurement reports

**Note:** If you wish to save the raw data for the measurement data reports, before starting measurement you must tick the "Save raw-data measurement files" box under “Preferences” > “Data storage”. For further information please see chapter 8.2.3 “Data storage” on page 61.

### 7.7.1 Measurement report finder

The DigiVision software has a convenient archiving facility for measurement reports. It lets you save all the measurements that have been made, and then retrieve them again as required. You can use the "Find reports" facility to perform the following actions for one or more reports: view, analyze, print, save as a PDF document or export to an Excel file.



This is how it works

- To access the report search, click on "Measure" in the left-hand menu bar and then on "Find and manage measurement reports". The “Find reports” window now opens.

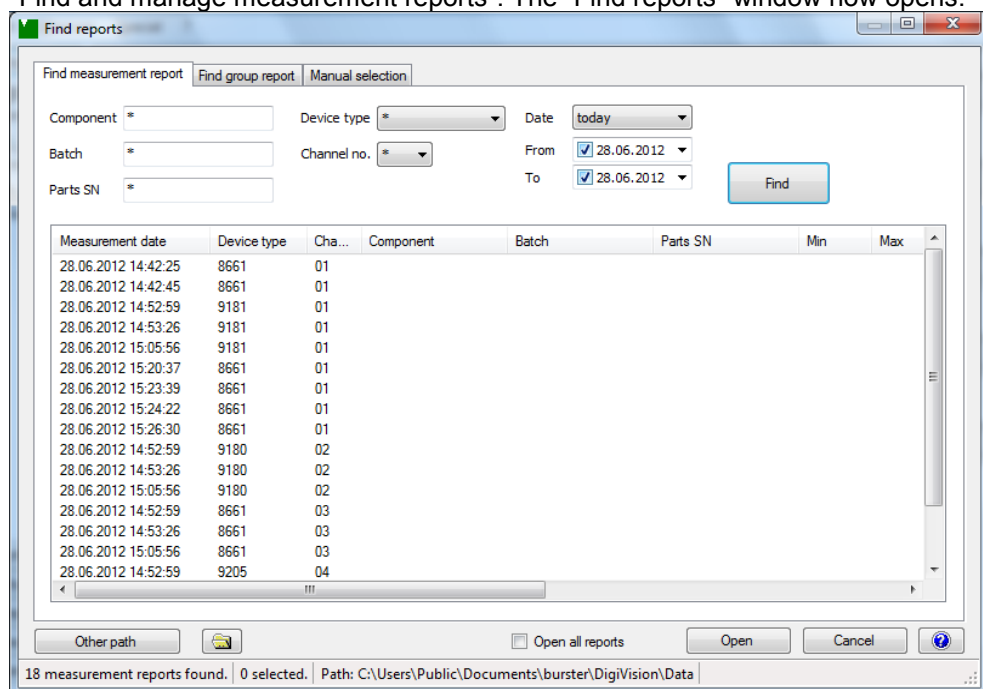

Measurement date	Device type	Cha...	Component	Batch	Parts SN	Min	Max
28.06.2012 14:42:25	8661	01					
28.06.2012 14:42:45	8661	01					
28.06.2012 14:52:59	9181	01					
28.06.2012 14:53:26	9181	01					
28.06.2012 15:05:56	9181	01					
28.06.2012 15:20:37	8661	01					
28.06.2012 15:23:39	8661	01					
28.06.2012 15:24:22	8661	01					
28.06.2012 15:26:30	8661	01					
28.06.2012 14:52:59	9180	02					
28.06.2012 14:53:26	9180	02					
28.06.2012 15:05:56	9180	02					
28.06.2012 14:52:59	8661	03					
28.06.2012 14:53:26	8661	03					
28.06.2012 15:05:56	8661	03					
28.06.2012 14:52:59	9205	04					

- Here you have a choice of two different report types: Measurement report or group report. A measurement report displays each individual physical variable ( $M$ ,  $\alpha$ ,  $n$ ,  $P$ ), which are presented as one measurement sequence. A group report is a report that contains all the measurement sequences. The individual measurement reports involved in the measurement are held here. This makes it easier to assign the measured variable. Select the report type you require.

# Model 8661

3. Various filters such as device type, date and channel no. can be used to reduce the number of reports displayed for a clearer picture. Select the required report by left-clicking on it. If you wish to select more than one report, hold down the **[CTRL]** key on your keyboard at the same time.
4. Once you have selected the report(s) you require, click on "Open".

## 7.7.2 Archive viewer

Once you have selected the measurement reports from the "Find reports" window, the "Archive viewer" opens. This gives you detailed information on your measurement. The "Archive viewer" is also the management center for viewing and editing reports.

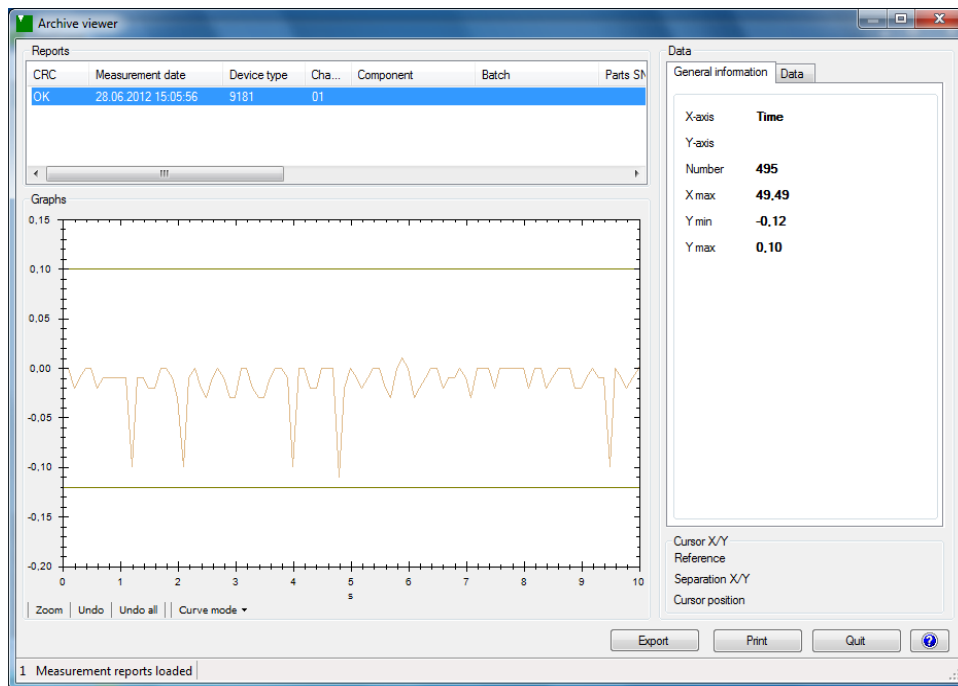

Diagram 32: Archive viewer



### This is how it works

1. To view each measurement report separately, left-click on the required report.
2. To group together several measurement reports, i.e. to superimpose the measurement curves in one graph, press the **[CTRL]** button while left-clicking on the measurement reports you wish to display.

## 7.7.3 Exporting reports to Excel

**Note:** To export the measurement reports in the Excel format you will need Microsoft Excel or an equivalent piece of software.



### This is how it works

1. Once you have selected the measurement reports you require in the “Archive viewer”, click on "Export" to export an XLS file.
2. Specify whether you wish to export all the reports or just those you have selected.
3. Specify the path to the directory in which you wish to save the file. The default setting is to save the XLS files in the same directory as the measurement reports. You can also specify an alternative path here.

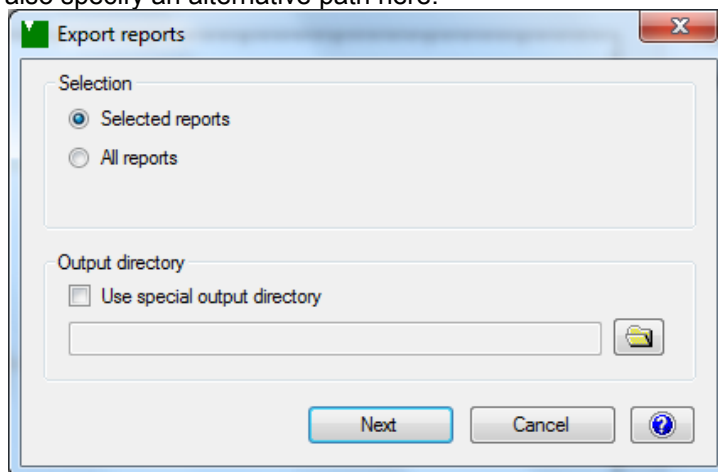

4. Click on “Next”.
5. The data is now converted and saved in the specified directory.

# Model 8661

## 7.7.4 Print reports



This is how it works

1. Once you have selected the reports you require in the "Archive viewer", you can print them by clicking the "Print" button.

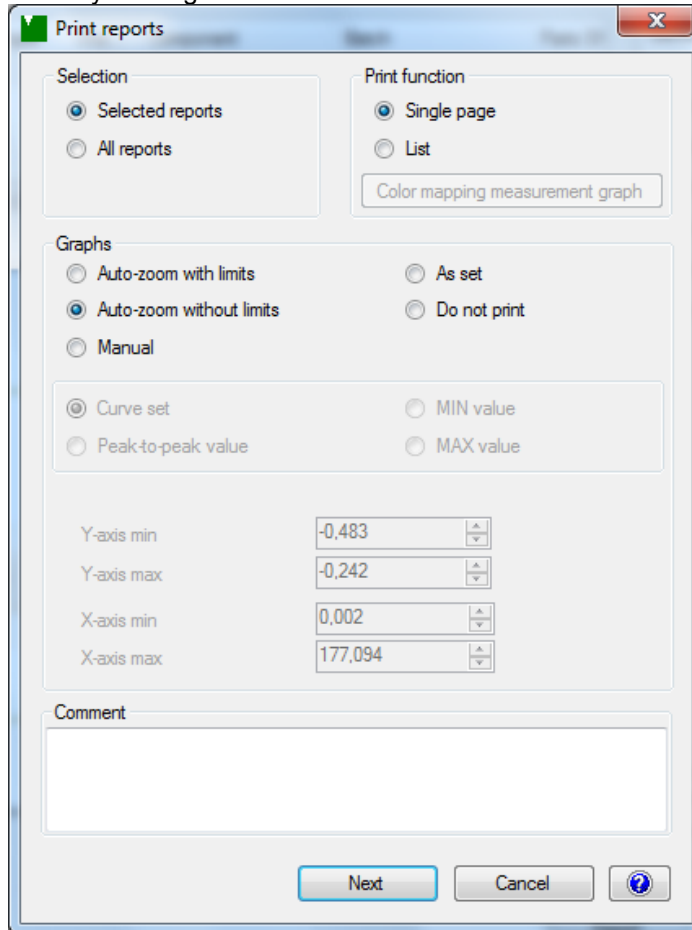

2. Now select how you want the reports printed.

3. Click on "Next".

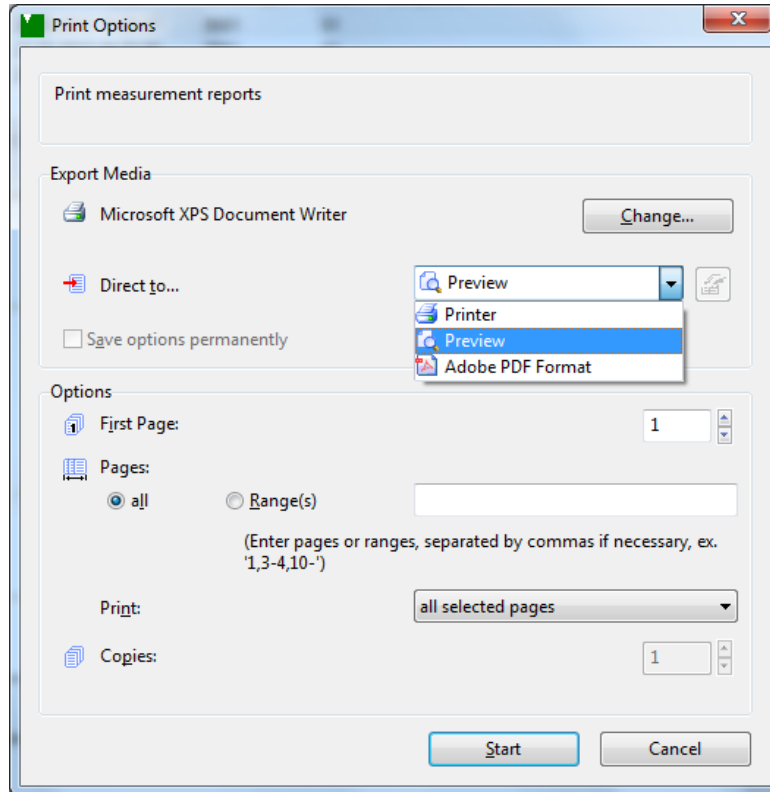

4. Now specify how you want the data to be output. You have the option to choose a printer, print preview or output as a PDF document.
5. Click on "Start".
6. The data is now output in the specified form.



# Model 8661

## 8 Software DigiVision

### 8.1 System requirements

Name	Manufacturer / description
Operating systems	Windows Server 2003, Windows XP, Windows 7, Windows 8, Windows 10
Processor	Pentium 1200 MHz minimum, Pentium 2.0 GHz recommended
Graphics card	At least VGA 800 x 600; minimum 256 colors
Memory	At least 256 MB RAM (Windows XP), at least 512 MB (Windows Server 2003, Windows 7)
Hard disk	Approx. 500 MB free space
Input devices	MS-compatible mouse, standard keyboard
Font setting	Small fonts

### 8.2 Software installation

**IMPORTANT:** To install DigiVision, the user needs to be logged on as an administrator.



This is how it works

1. To start installation of the DigiVision configuration and analysis software, insert the supplied CD-ROM in the CD-ROM drive.
2. Switch to the directory of your CD-ROM drive and run the setup wizard by double-clicking on "Run autorun.exe".

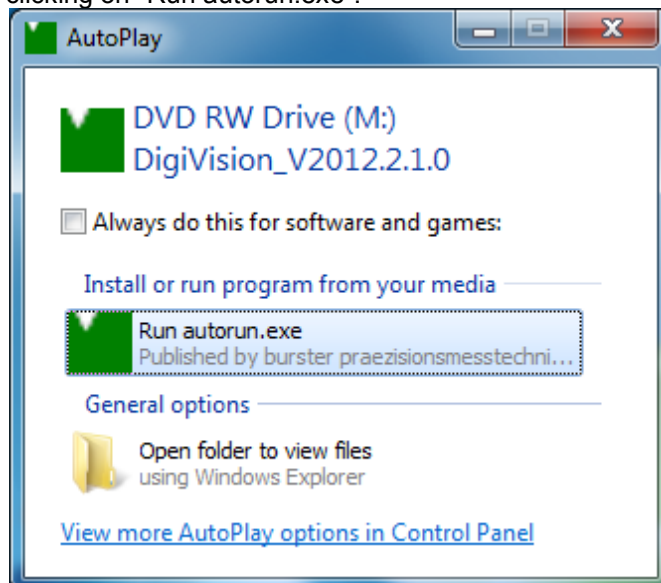

3. Double-click to choose a language and start installation.



**Note:** If Microsoft .NET Framework 4.0 is not already installed on the PC, it is installed automatically.

4. Click "Next".

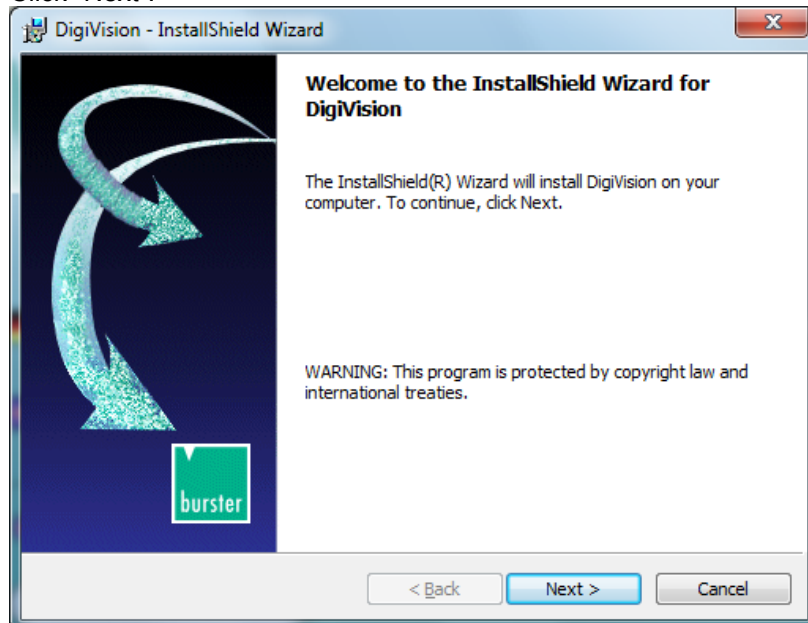

# Model 8661

5. Accept the license agreement, then confirm by clicking "Next". The installation will terminate, if you do not accept the license agreement.

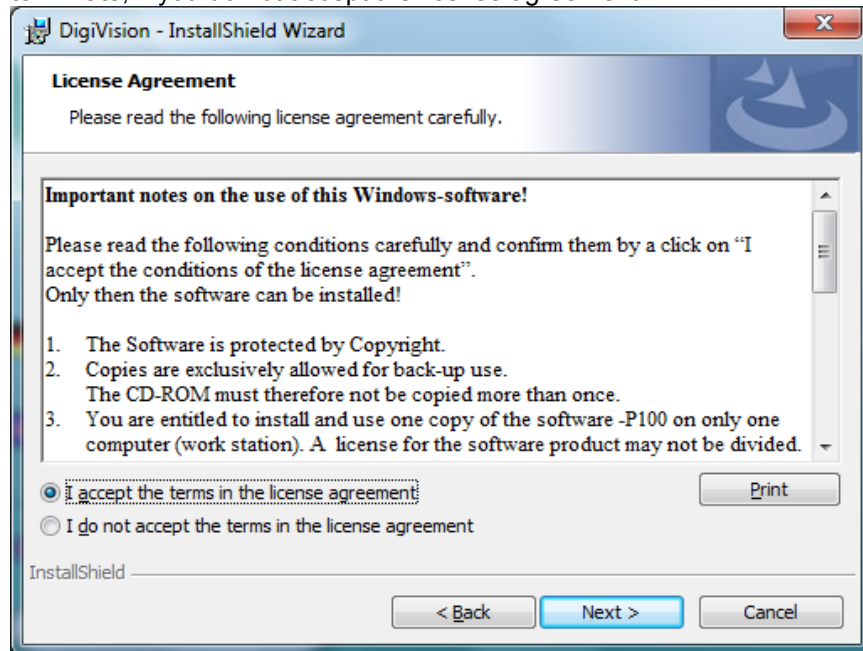

6. The next installation window lets you review all the relevant information about the software version you are installing. After installation, you can view this information in the "readme.txt" file. Click "Next".
7. Enter a user name and the name of your organization or company and click "Next".

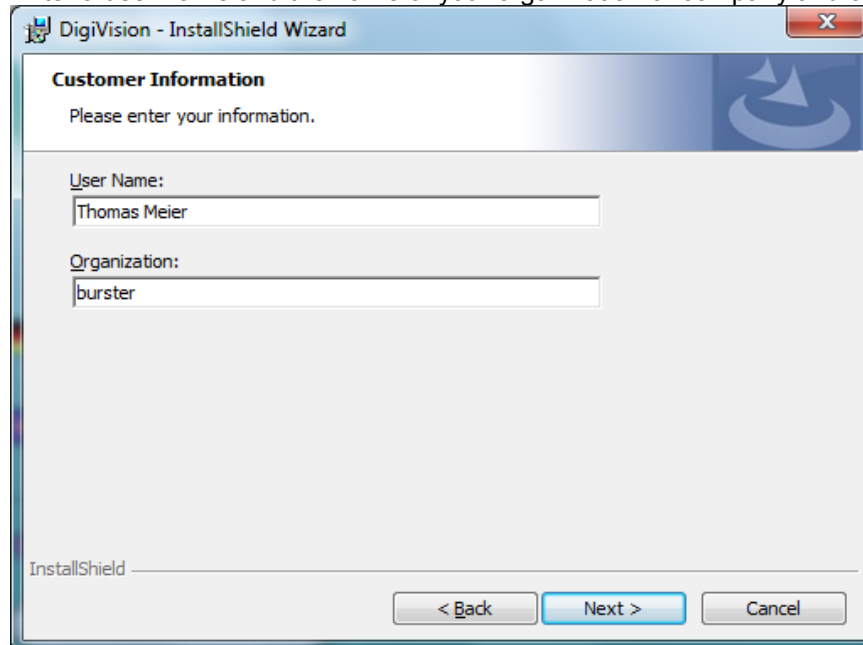

8. Click "Install" to start the installation.

**IMPORTANT:** Make a note of the installation path. The sensor driver is located in a subdirectory. You will need to know this path later when you install the driver.

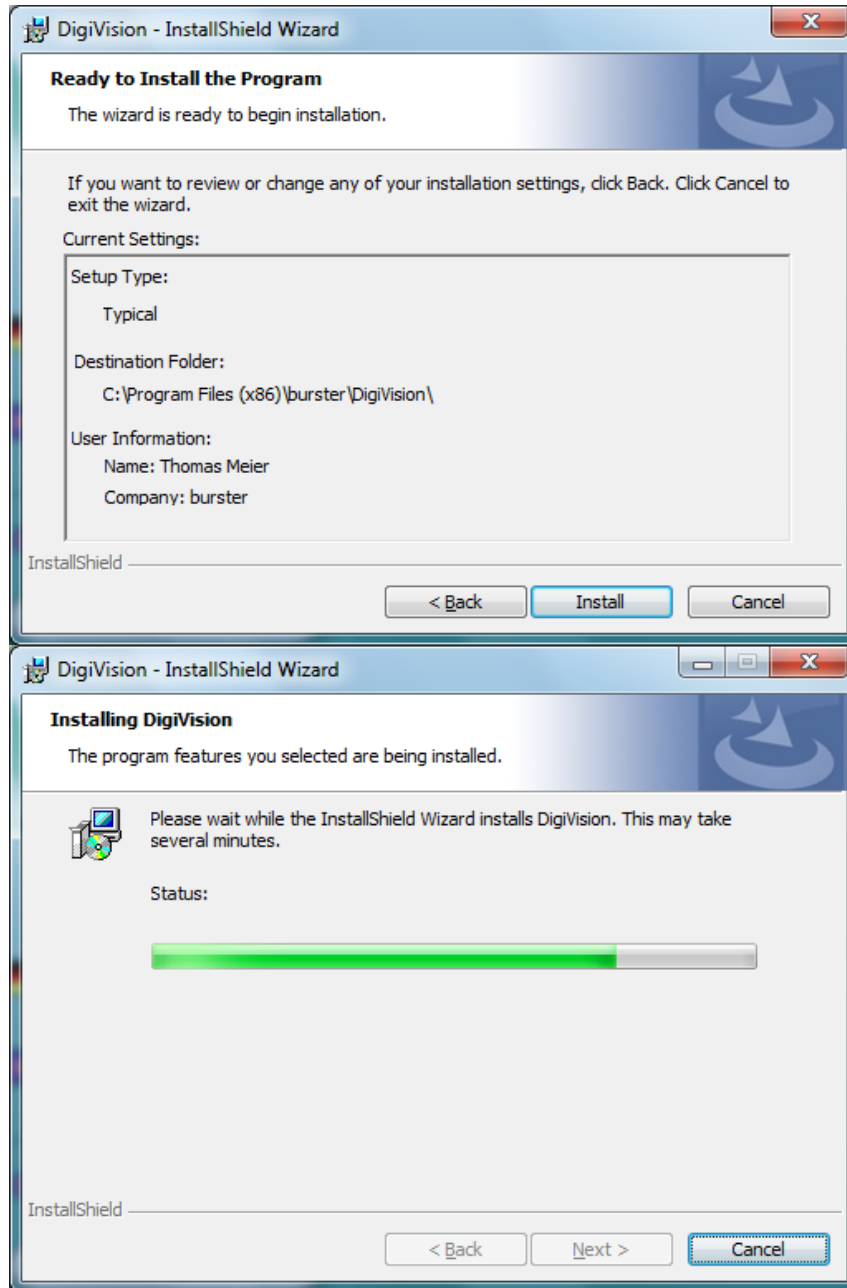

# Model 8661

- Click “Finish” to close the setup wizard. The DigiVision configuration and analysis software has been successfully installed on your system.

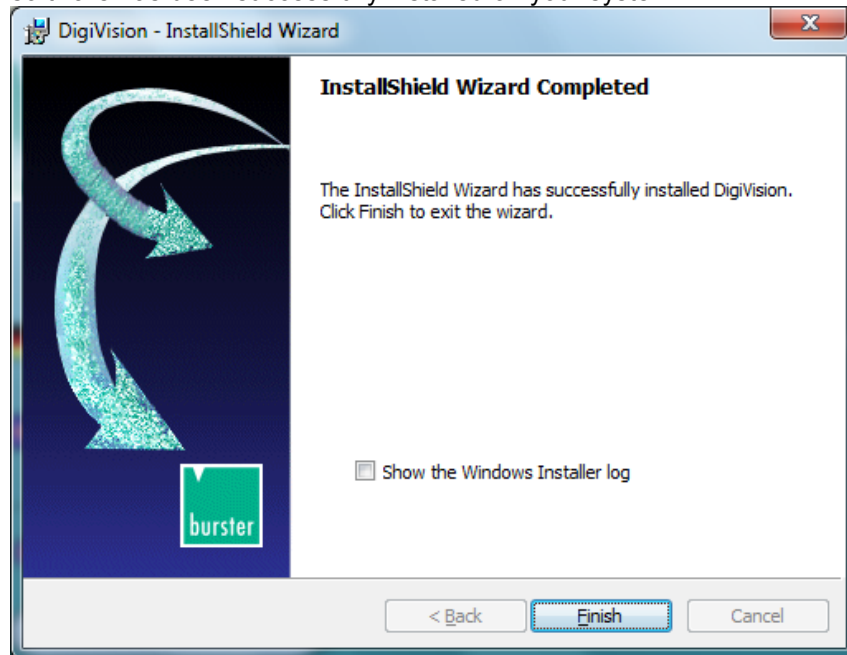

## 8.2.1 Driver installation

This guide describes how to install the driver software under Windows 7. Installation may differ under other operating systems.

**IMPORTANT:** To install the driver, the user needs to be logged on as an administrator.



### This is how it works

- Connect the USB cable to the torque sensor model 8661 and plug the other end of the USB cable into a free USB port on your PC. If you are using a USB hub, make sure that it can supply sufficient current.
- Open the “Device Manager”.  
Go to “Start” > “Control Panel” > “Hardware” > “Device Manager”.
- In “Device Manager”, select the torque sensor’s model 8661 interface.

4. Select "Update Driver Software...".

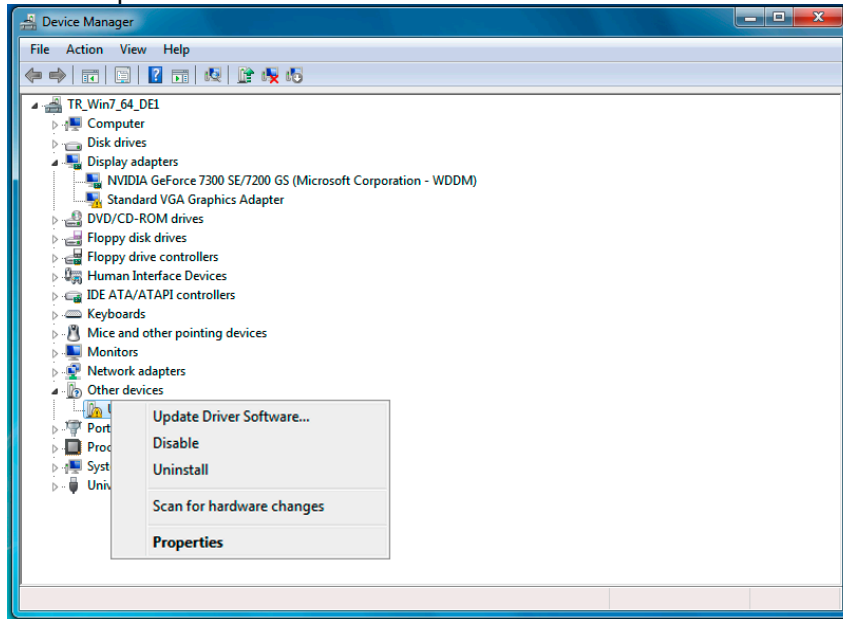

5. Select "Browse my computer for driver software".

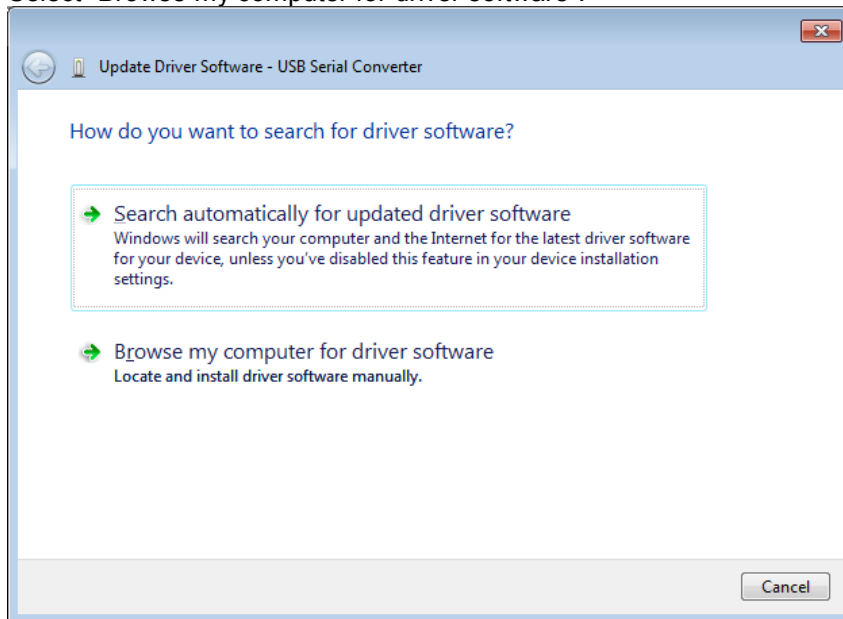

# Model 8661

- Specify the path to the driver installation files. After installing the DigiVision configuration and analysis software, the driver installation files are located in the folder you specified when installing DigiVision. You can use the "Browse" button to select the correct directory.

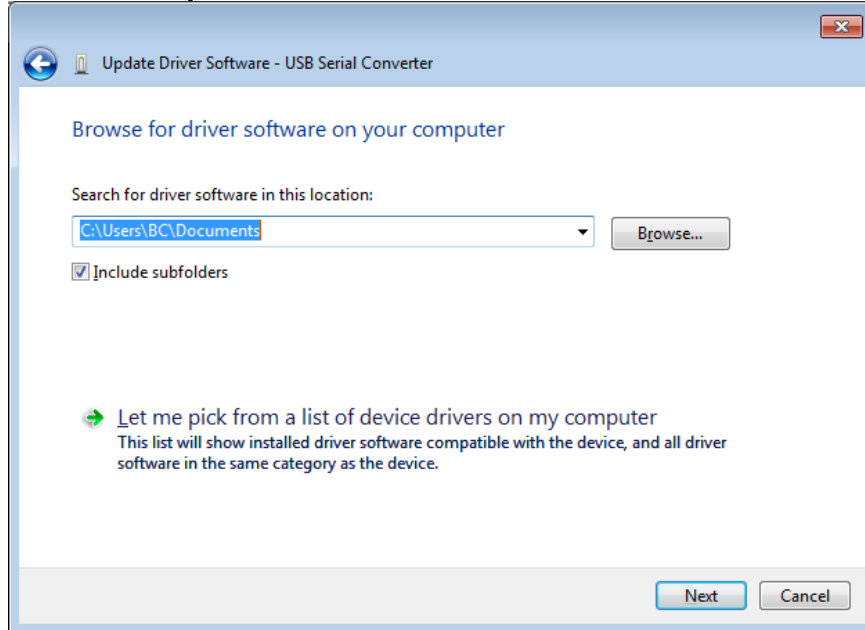

- Confirm your selection by clicking "OK".

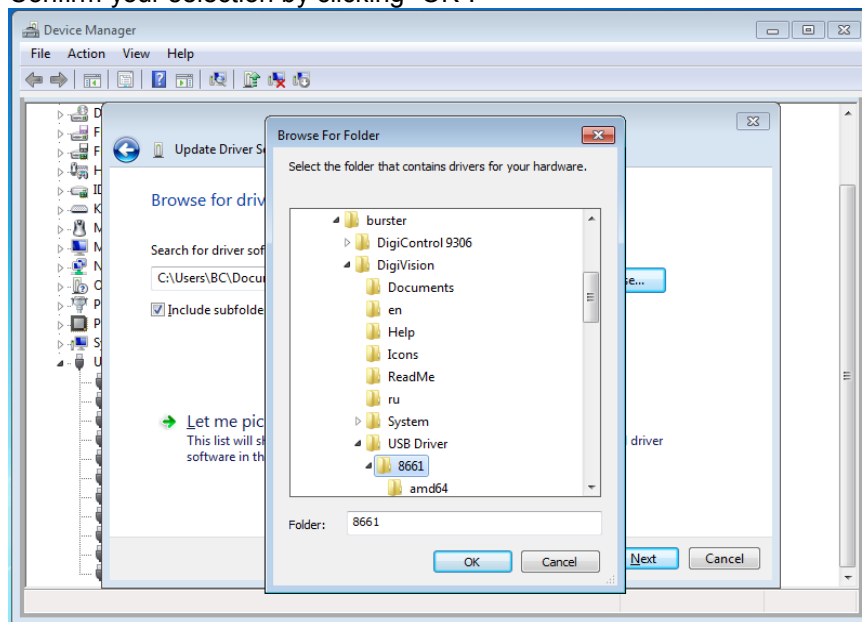

8. Confirm your selection by clicking “Next”.

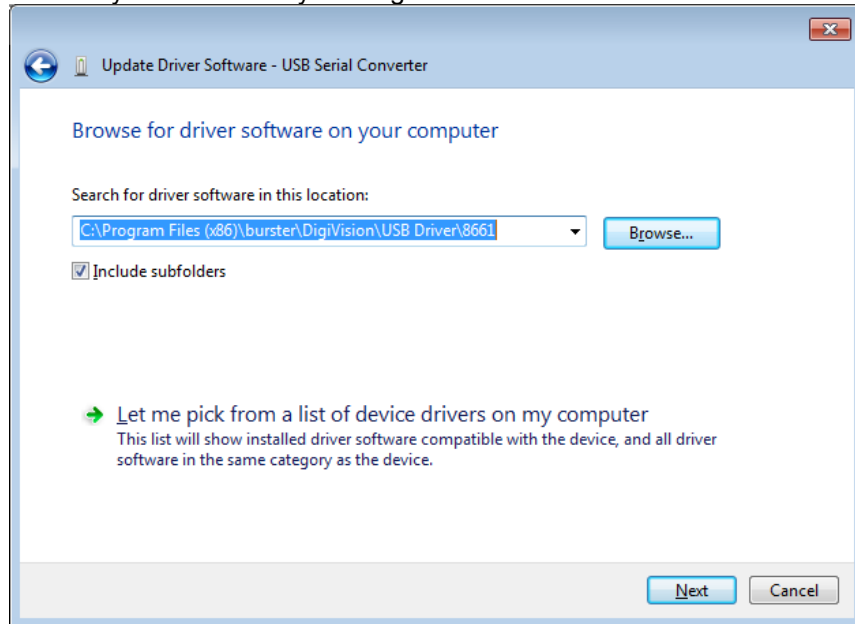

9. The operating system now confirms that the driver for the torque sensor model 8661 has been installed successfully.

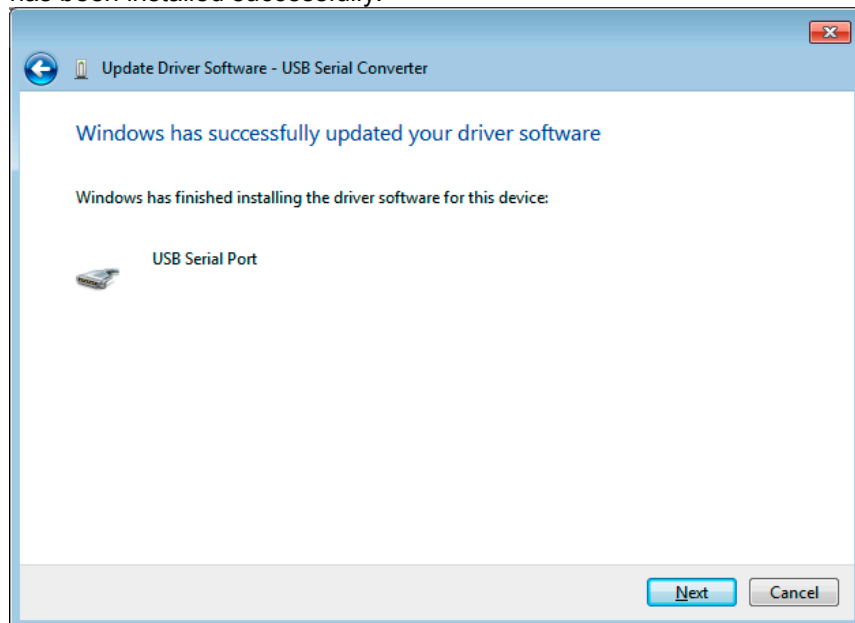

10. Then run the installation for the virtual COM port.



# Model 8661

## 8.2.2 Installation for the virtual COM port



This is how it works

1. Open the “Device Manager”.  
Go to “Start” > “Control Panel” > “Hardware” > “Device Manager”.
2. Right-click on “USB Serial Port”.

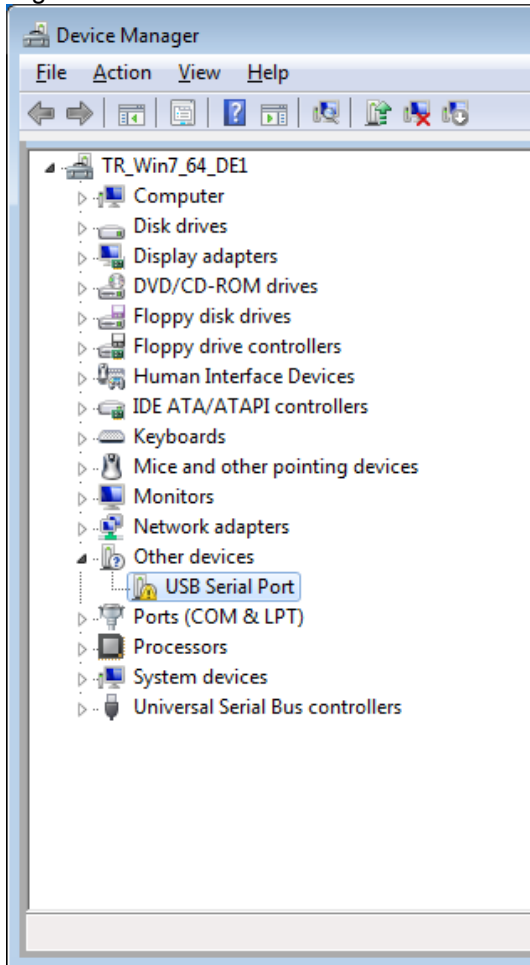

3. Click on “Update Driver Software...”.

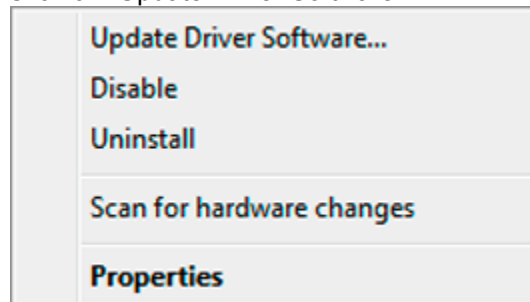

4. Select "Browse my computer for driver software".

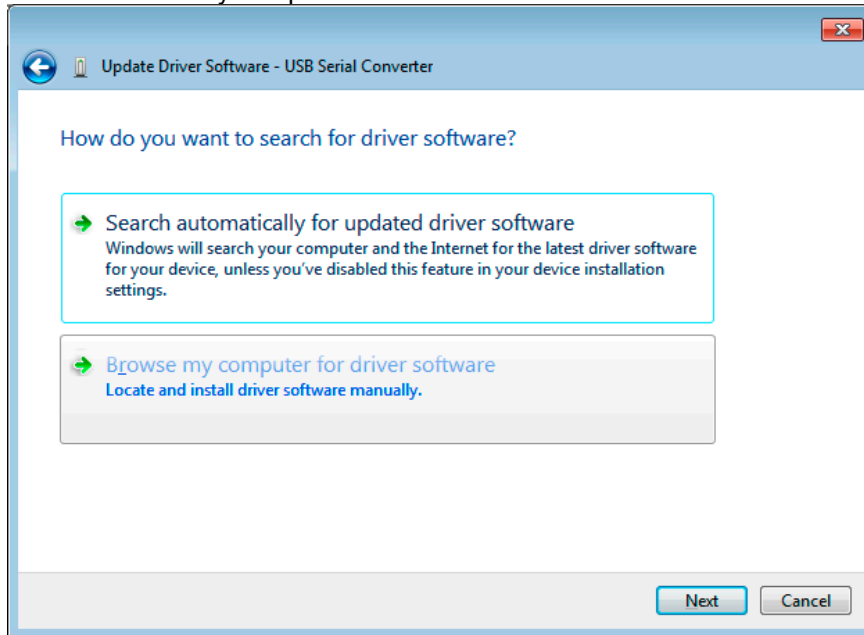

5. Enter the same path you specified in the first part of the installation procedure. You can use the "Browse" button to select the correct directory.

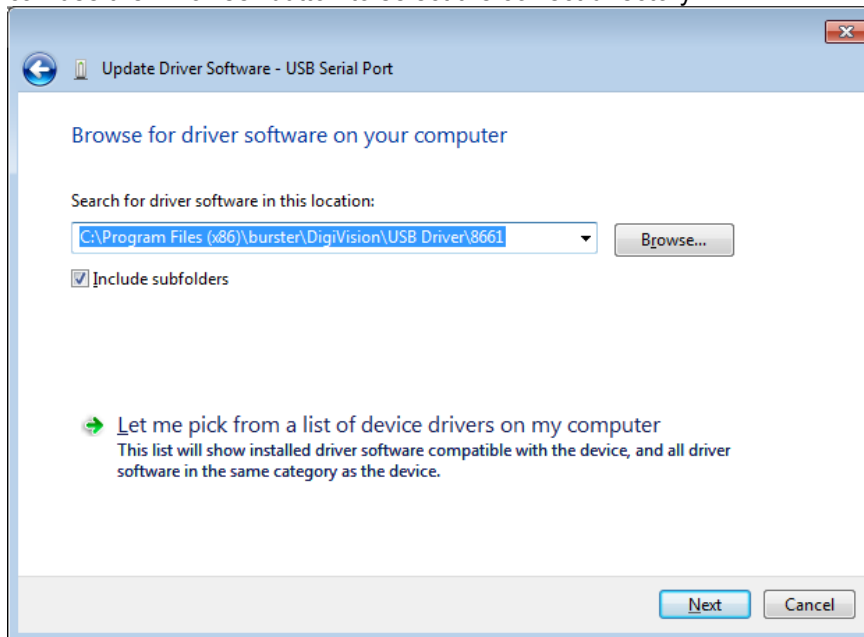

# Model 8661

6. Confirm your selection by clicking "Next".

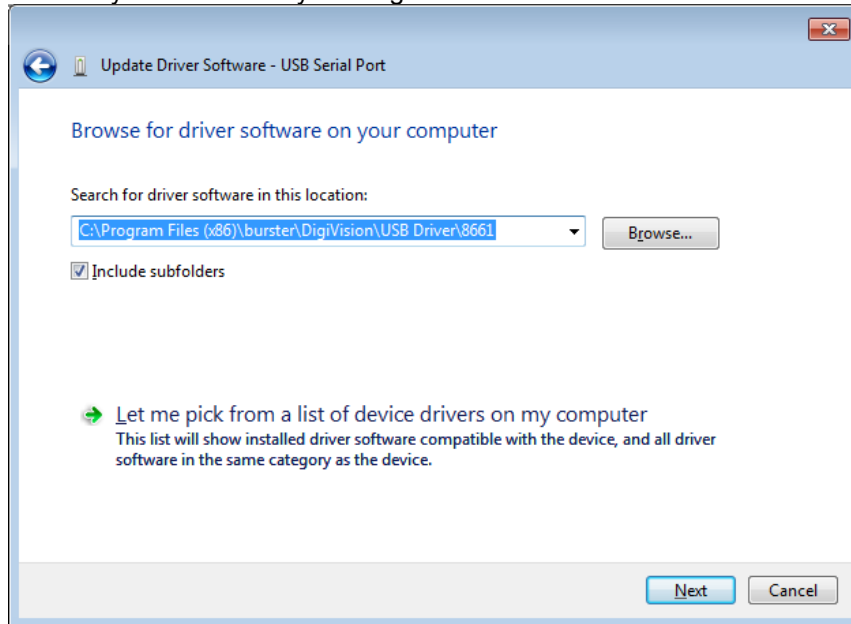

7. The operating system confirms, that the virtual COM port has been installed. Click "Close" to finish the installation.

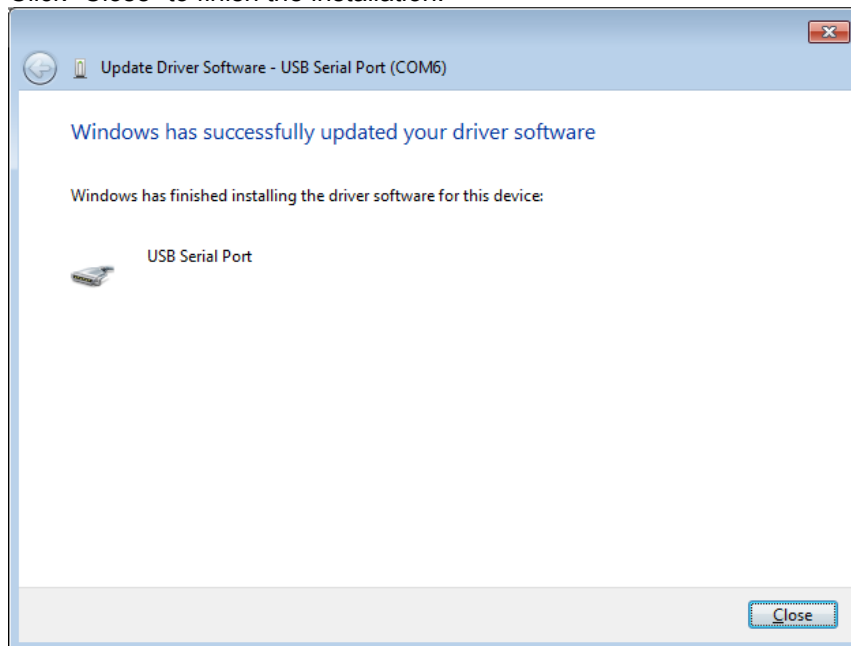

8. A new device called "USB Serial Port" appears in "Device Manager". The COM port listed here is now assigned to the USB torque sensor model 8661, and is always visible when the USB torque sensor model 8661 is plugged into a USB port.

9. If you are using more than one USB torque sensor model 8661 at the same time on one computer, then each sensor is assigned to a separate COM port.

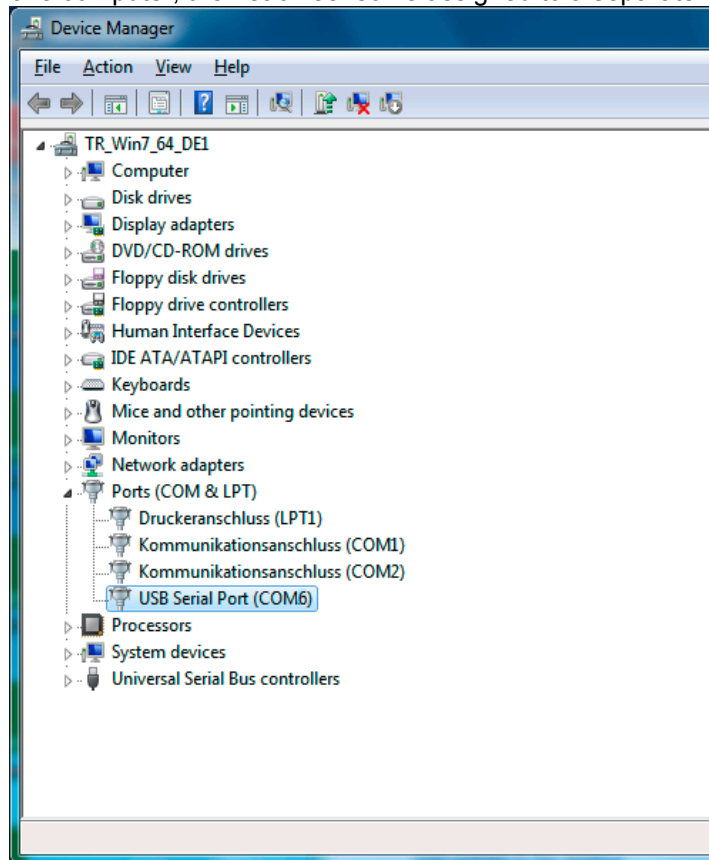

**Note:** If a previously installed USB torque sensor model 8661 is plugged in again, Administrator rights are no longer needed. You will only need Administrator rights again the first time you connect and install a different USB torque sensor model 8661.

If you wish to connect another USB torque sensor model 8661, you will need to go through the installation procedure again. The virtual COM port is installed on the basis of the serial number, i.e. you can use the same COM port to drive the USB torque sensor model 8661 on any USB port on the PC.

10. Restart the PC.
11. Launch the DigiVision configuration and analysis software.

# Model 8661

## 8.2.3 Data storage

In order to be able to store the raw data from measurements carried out, you simply need to enable the option “Save raw-data measurement files” once before starting the measurement.



**This is how it works**

1. In the DigiVision device list, click on “Edit” > “Preferences” > “Data storage”.
2. Enable the checkbox for “Save raw-data measurement files” and click “OK”.

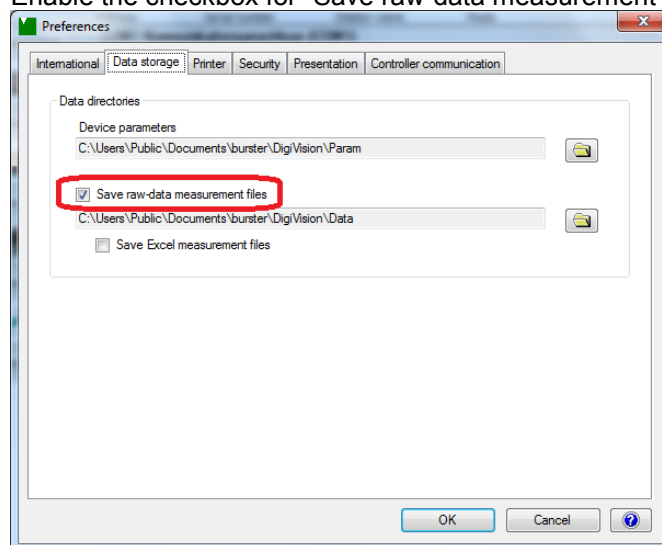

## 8.3 Software version & licensing

### 8.3.1 8661-P001

The USB version of the torque sensor model 8661 is supplied with the free 8661-P001 version of the DigiVision configuration and analysis software. This version provides the following functions:

- 1-channel measurement for one sensor.
- Maximum sampling rate of 200 measured values per second.
- Additional display of angle or speed (for relevant sensor model).
- Calculation of mechanical power (only for the angle or speed measurement option).

## 8.3.2 8661-P100

An upgrade from version 8661-P001 to version 8661-P100 of the DigiVision software can optionally be purchased (licence code). In addition to the functions in the basic 8661-P001 version, this version includes the following extra functions:

- 16-channel measurement for up to 16 sensors in parallel.
- Maximum sampling rate of 1000\* (2000\*) measured values per second.
- Additional display of angle or speed (for relevant sensor model).
- Calculation of mechanical power (only for the angle or speed measurement option).

\*For the USB version of the torque sensor model 8661 without the speed or angle measurement option selected, you can set a measurement rate of up to 2000 measured values per second. If the speed or angle measurement option is selected, a separate measurement rate of 1000 measured values per second is possible for each measurement channel.

In the multichannel 8661-P100 version of DigiVision, you can switch between different views (for further details see chapter 7.5 “Display” on page 41).



### This is how it works

1. Click on “full-screen” to get a larger view of the measurement curve. This enlarges the individual graph to full-screen size during the measurement process.
2. Click on “Normal” to revert to the standard view (see chapter 7.5 “Display” on page 41).

# Model 8661

## 8.3.3 8661-P200

DigiVision version 8661-P200 is available as an upgrade for DigiVision version 8661-P100. In addition to the functions in 8661-P100, this version includes the following extra functions:

- Configurable extra maths channels.
- 32-channel measurement for up to 32 sensors in parallel.

See below for an example of how to configure an extra maths channel. Simple calculations such as calculating the efficiency or difference speeds and also complex mathematical operations can be performed.

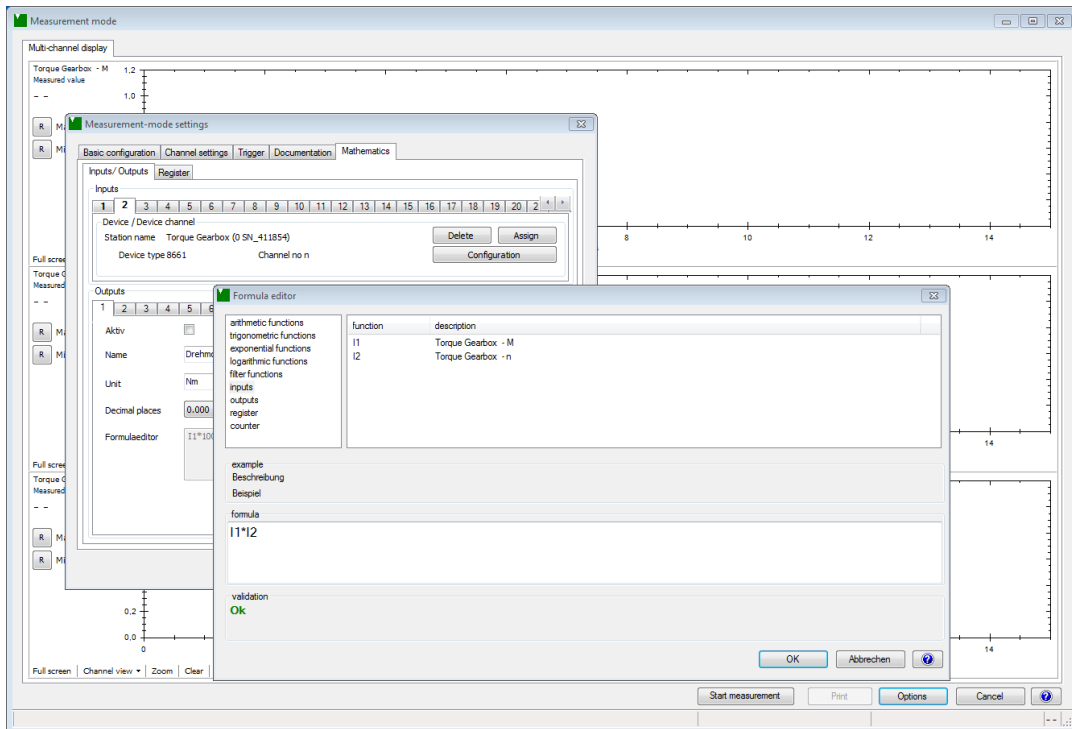

Diagram 33: Configuring an extra maths channel (8661-P200)

## 8.3.4 Licensing

To activate your copy of DigiVision, follow these steps:



This is how it works

1. Click “?” > “Licensing”.

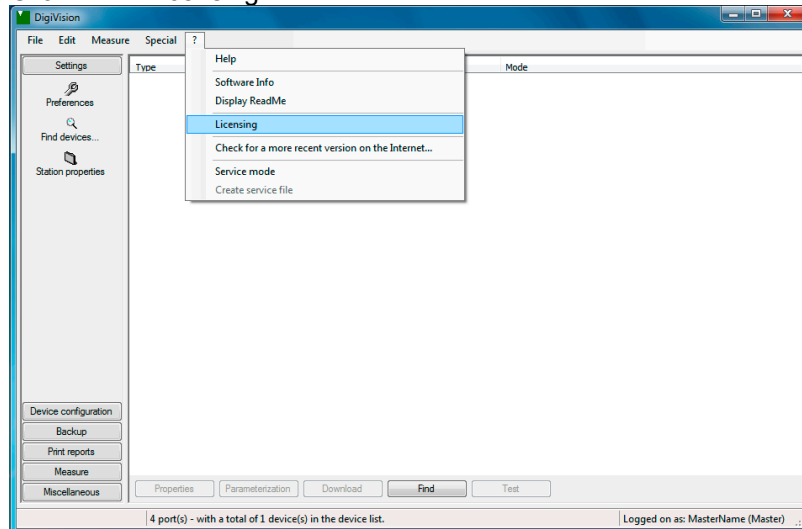

2. Enter your activation code. This could look like this: 12345-12345-12345-12345. Make sure, that you enter the activation code exactly as it appears in your software licensing documents.

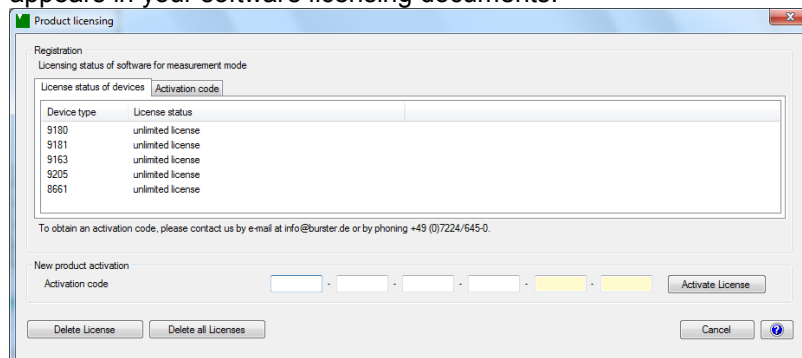

3. Click “Activate License”. When the correct activation code is entered, the corresponding device type is activated. If the activation code is invalid, the licensing process is terminated.



# Model 8661

## 9 Options

### 9.1 Angle / speed measurement

#### 9.1.1 General information

The torque sensor model 8661, both the analog and USB version, can be equipped with integral angle/speed measurement. Chapter 9.1.2 “Details” on page 65 contains technical details for analysing the speed/angle signals.

Encoder disks with a different number of increments are provided for the integral angle/speed measurement. For electronic and/or mechanical reasons, every resolution is not available for every measurement range.

**Example 1:** For a torque sensor model 8661 with a 1000 Nm measurement range, the large shaft diameter means that it is not possible to use an encoder disk with fewer than 1024 increments.

**Example 2:** For a torque sensor model 8661 with a 0.05 Nm measurement range, an encoder disk with 240 increments must be used if the sensor is meant to measure the full speed of  $25,000 \frac{1}{min}$ .

#### Resultant dependencies and availabilities

Increments	Maximum resolution	Maximum speed measurement	Available from [Nm]	Available up to [Nm]
240	0.75°	$25.000 \frac{1}{min}$	0 ... 0.02	0 ... 2
400	0.225°	$15.000 \frac{1}{min}$	0 ... 0.02	0 ... 200
1024	0.088°	$6.000 \frac{1}{min}$	0 ... 0.02	0 ... 1000
2000	0.045°	$3.000 \frac{1}{min}$	0 ... 5	0 ... 200

#### 9.1.2 Details

An opto encoder scans a rotating encoder disk. This incremental encoder disk is made from a transparent material with opaque lines on it. This design is basically a high-resolution and fast light barrier. In operation, it generates a certain number of electrical pulses with each rotation. The frequency of these pulses is therefore dependent on the rotational speed of the shaft and the number of lines on the encoder disk.

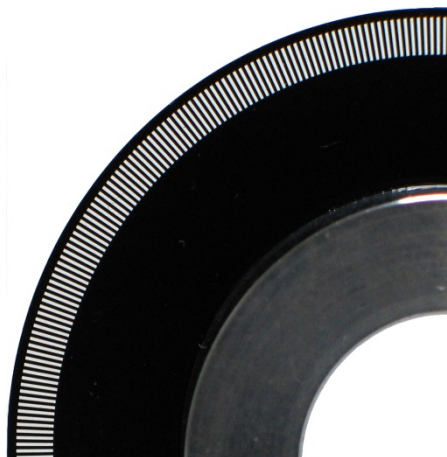

Diagram 34: Close-up view of the encoder disk

If the torque sensor model 8661 includes the speed/angle option, the speed/angle output supplies a 5 V TTL signal. However, you can also use this output as an open collector output. For the USB version of the torque sensor model 8661, the measurement data for the torque and also for speed and angle is transmitted digitally via USB.

The principle of measuring angular displacement is the same as for measuring rotational speed. However, in this case the sensor reads two channels. The electrical pulses from the two channels A and B are offset by 90°, which also allows the shaft's direction of rotation to be identified.

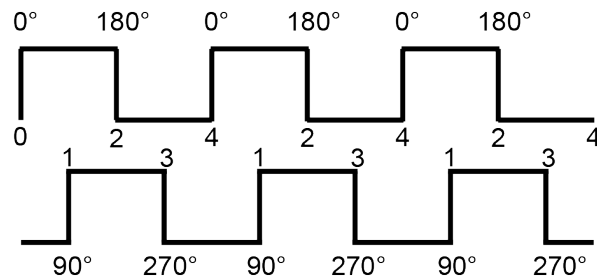

Diagram 35: Angular displacement measurement, channel offset 90°

To detect the angle, you need to evaluate the rising and falling pulse edges for both channels (four-edge decoding). Hence the angular resolution is four times the number of lines on the encoder disk. An encoder disk with 2000 lines therefore gives a resolution of  $360^\circ / (4 \times 2000) = 0.045^\circ$ .

For more information on the sign convention, see chapter 2.9 “Definitions” on page 13.

# Model 8661

## 9.2 Dual-range sensor

### 9.2.1 Switching between ranges (dual-range sensor)

Appropriate builds of the torque sensor model 8661 can measure over two ranges.

This option is available for measuring ranges between 0 ... ± 0.5 Nm and 0 ... ± 1000 Nm.

### 9.2.2 Possible range extension of the nominal torque

The following extensions are available: 1:10, 1:5, 1:4. For further information please see data sheet of torque sensor model 8661.

### 9.2.3 Switching between measurement range

The sensor electronics will switch the measurement range if the user applies the supply voltage  $U_b$  to pin L of the connector. The additional measurement range will remain enabled as long as this voltage is applied to pin L. The maximum switching time is 50 milliseconds.

The ground reference is internally the reference ground for  $U_b$  on pin E and pin J. There is no need to provide an additional ground connection.

For the USB version of the torque sensor model 8661, the measurement range is switched via DigiVision (see chapter 7.2 "Device settings" on page 33).

	Logic state	Voltage level
Default measurement range	Pin L = 0	$U_{\text{Pin L}} = 0 \dots 3 \text{ V}$
Second measurement range	Pin L = 1	$U_{\text{Pin L}} = U_b = 10 \dots 30 \text{ V}$

### 9.2.4 Connector pin assignments (dual-range sensor, not USB)

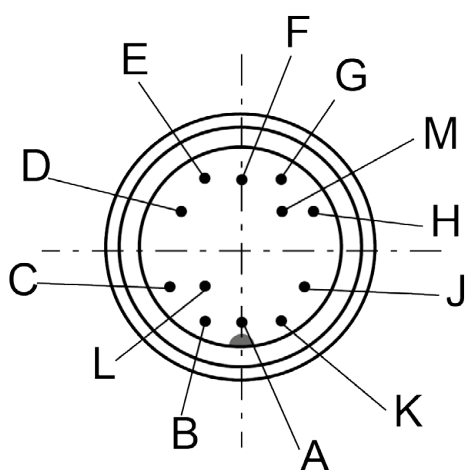

Diagram 36: View of the plug

12-pin plug	Function
A	Not used
B	Angular displacement, channel B (option)
C	Torque, voltage output
D	Torque, output ground
E	Sensor supply/angle of rotation, ground
F	Sensor supply, voltage
G	Angular displacement, channel A (option)
H	Not used
J	Sensor supply, ground
K	Control input
L	Switching between measuring ranges
M	Not used

## 9.2.5 Connection diagram (dual-range sensor, not USB)

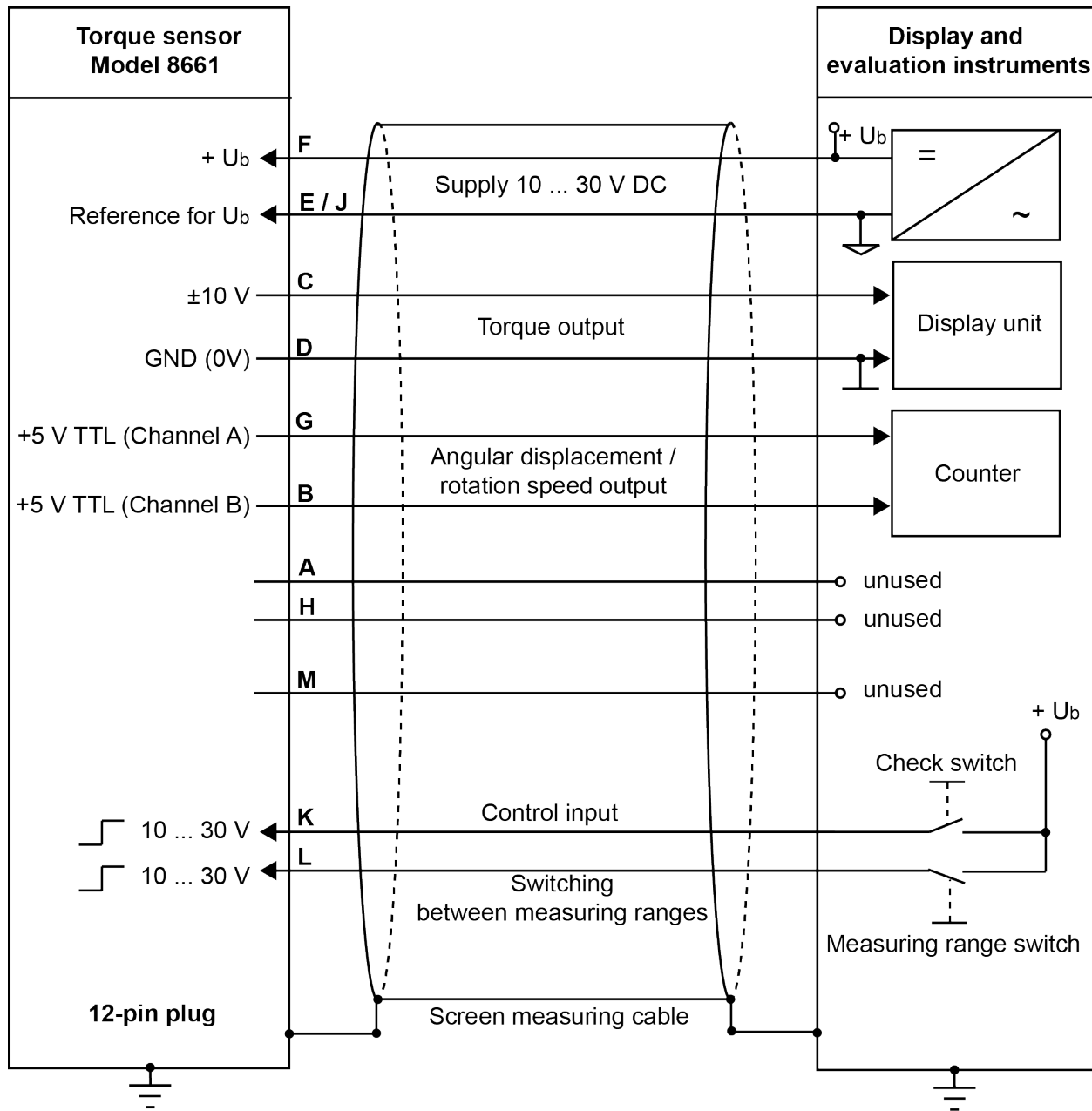

Diagram 37: Connection diagram dual-range sensor

**IMPORTANT:** Pin E and pin J are the common reference ground for  $U_b$ , the speed measurement, angle measurement and for the range switchover and test input.

# Model 8661

## 9.2.6 Status display (dual-range sensor)

The status indicator for the dual-range sensor differs from the standard version. In addition to the indicators in the standard version, the yellow LED also indicates the selected measurement range for the dual-range sensor.

Status display	Cause / meaning
Green LED flashes	Torque is less than 10 % of the set range.
Green LED lit	Torque is between 10 % and 100 % of the set range.
Red LED lit	<b>Overload!</b> Torque is greater than 100 % of the set range.
Yellow LED is off	Range 1:1.
Yellow LED lit	Other extended range.

**Note:** Some models of the torque sensor model 8661 go through a self-test mode lasting 4 seconds after power-up. Once the self-test has finished, all the LEDs light up solidly for about 1 s.

## 10 Calibration and adjustment

The torque sensors model 8661 from burster praezisionsmesstechnik gmbh & co. kg are already traceably adjusted and tested in the factory. As an option we offer factory calibration of the torque sensor model 8661.

### 10.1 Factory calibration

As part of the traceable burster factory calibration, the torque sensor model 8661 is checked for calibratability, and is then calibrated and provided with a calibration label and a calibration certificate.

The burster factory calibration certificate includes the following information as a minimum:

- Measurement values and measurement uncertainty.
- Reference standards used including measurement uncertainty and traceability
- Zero offset, output sensitivity and interpolation error.
- Peak-to-peak range, hysteresis voltage and toggle (relative zero offset right-left).

### 10.2 DAkkS (DKD) calibration (DIN 51309)

DKD calibration involves calibrating the torque sensor model 8661 in accordance with guidelines from DAkkS (the German accreditation body) in an ISO-17025 accredited calibration laboratory.

It is essentially the user's responsibility to set suitable recalibration dates. In the case of a DAkkS calibration, the user should note that based on current standards, the validity of the DAkkS calibration lasts for no longer than 26 months.

### 10.3 Recalibration

Quality management standards require regular calibration of any measurement and test equipment that you use in quality-related processes. The reason for this is to ensure measurements are always made correctly, thereby keeping the risk of measurement errors in check.

We recommend that all measurement and test equipment is inspected every 12 months. We advise an immediate inspection if any damage is suspected.

Shorter intervals are recommended in the following cases:

- Torque sensor model 8661 overload.
- After repair.
- After improper use of the torque sensor model 8661.
- When required by quality standards.
- Where there is a specific traceability requirement.

If you have any questions about the torque sensor model 8661 or calibration, please contact our Customer Service team by phone on +49-7224-645-53 or by email at [service@burster.com](mailto:service@burster.com).

# Model 8661

## 11 Taking out of use

- Remove the torque sensor model 8661 correctly.
- Protect the torque sensor model 8661 from knocks.
- Protect the torque sensor model 8661 against bending moments.
- Support the torque sensor model 8661.
- Do not drop the torque sensor model 8661 **under any circumstances**.

## 12 Technical data

Please refer to the enclosed data sheet for the technical specification. The latest version of the data sheet is available at: <http://www.burster.de/de/sensoren/drehmoment/p/detail/8661/>.

### 12.1 Electromagnetic compatibility

#### 12.1.1 Interference immunity

Interference immunity to EN 61326-2-3:2006

Industrial locations

#### 12.1.2 Emitted interference

Emitted interference to EN 61326-2-3:2006



# Model 8661

## 13 Accessories

Please refer to the enclosed data sheet for detailed information about the accessories. The latest version of the data sheet is available at: <http://www.burster.de/de/sensoren/drehmoment/p/detail/8661/>.

### 13.1 Software

Please refer to the enclosed data sheet for detailed information about the DigiVision configuration and analysis software. The latest version of the data sheet is available at: <http://www.burster.de/de/sensoren/drehmoment/p/detail/8661/>.

## 14 Disposal



### **Battery disposal**

As an end user, you are required by law (battery ordinance) to return all used batteries and rechargeable batteries; the disposal through household waste is prohibited. By buying the herein described device you are concerned by this law. Please dispose of your batteries and rechargeable batteries correctly. Hand them to waste disposal sites either at your premises or at our company or at any place where batteries/rechargeable batteries are sold.

### **Equipment disposal**

Please fulfill your legal obligations and dispose of unserviceable equipment in accordance with applicable legal requirements. Thus you contribute to environmental protection.